

Philmac 3G Metric™

the connection you can trust



3 G METRIC™

CONTENTS

Standards	1	Metric Fittings 75 - 110mm	11
Introduction	2	- Tapping Saddles Metric	11
- Benefits	2	Universal Transition Fittings	12
Installation Instructions	3	Valves	13
- Tapping Saddles Chart	3	- Back Flow Prevention valves	13
System Design Considerations	4	Threaded Fittings	14
Materials & Components	5	- Accessories	14
- Principals of Operation	5		
Product Specifications	6		
3G Metric™ Range, Dimensions & Weights 20-63mm			
- Joiners, Slip Couplings, Reducing Joiners	7		
- End Connectors & Tees	8		
- Slip Tees, Reducing Tees & Tees	9		
- Elbows & End Caps	10		

STANDARDS

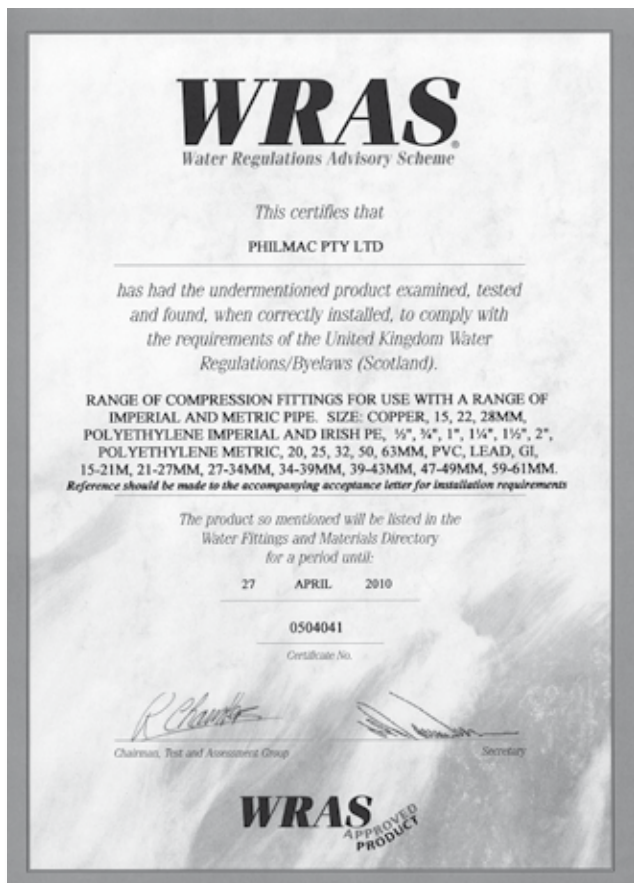

INTRODUCTION

Philmac, New Zealand's premier manufacturer of plastic compression fittings for polyethylene pipelines is proud to release 3G Metric™ – our third party and very latest generation of fittings to connect metric sized poly pipe.

Having taken international markets by storm since its release in 2005, 3G Metric™ is now set to make metric poly pipe connections in New Zealand easier than ever before. The culmination of years of research & development and utilisation of cutting-edge manufacturing technology and stringent testing, this new range of fittings is smaller, tougher and faster to use than ever before. And, it's 100% compatible with New Zealand's number one fitting to join rural poly pipe, Oasis 6 and 9 Bar.

Designed to make the job at hand so much easier, the Metric™ plastic compression fitting is the product of Philmac's unrelenting commitment to continuous improvement and a culture based on innovation and ingenuity.



BENEFITS

Fast and easy installation

- **Slide & Tighten™ technology:** 3G Metric™ incorporates all the benefits of Philmac's unique Slide & Tighten™ technology. No pipe preparation is needed and no force is required to push the pipe past the seal, so installation couldn't be faster or easier. Simply insert the pipe into the fitting until the first point of resistance is felt, and then tighten the nut. Assembly is so easy you can even do it under live conditions. No special tools are required, and there is no need to disassemble the fitting before use because the 3G Metric™ compression fitting is supplied pre-assembled and ready to use.
- **Compact design:** The size of the new Philmac 3G Metric™ compression fitting has been kept to a minimum, making the fitting ideal to use in confined areas. In addition to making connections with minimal turns of the nut, the design and size of the fitting means that in installations taking place between two fixed points, the manipulation of the pipe into the fitting becomes easy.
- **Easy disassembly:** The fitting has been designed so the split collet is released as soon as the nut is backed off, making disassembly easy.

Complete security

- **Dynamic sealing method:** The mechanical advantage of the nut thread compresses the seal into position, eliminating resistance when inserting the pipe into the fitting so there is no risk of seal distortion or displacement.
- **Visual stop:** The flange on the body of Philmac's 3G Metric™ compression fitting provides a visual stop to indicate when the nut is fully tightened. This removes any uncertainty from the installation process.
- **No loose components:** If the nut is removed there is no danger of losing components, as the collet and seal ring are retained in the body of the fitting. Losing components in the trench becomes a thing of the past.
- **Designed to minimise pipe twist:** The fitting has been designed to minimise pipe twist as the nut is tightened. Maximum pipe twist is approximately a quarter turn compared to one and a half turns with many other fittings. Pipe twist can impact on not only the connection you have just made but also on the connection at the other end of the line.

High performance

- **Made from advanced thermoplastic materials:** 3G Metric™ is manufactured from lightweight high performance thermoplastic materials with outstanding impact, UV, chemical and corrosion resistance. The material is non-toxic and taint-free.
- **Rated to 1600 kpa:** 3G Metric™ is pressure rated to 1600 kpa (PN16) to meet the needs of high pressure systems.
- **50 year+ design life:** Built to withstand the toughest conditions to ensure longevity and durability, 3G Metric™ has a 50 year+ design life.

Complete coverage

- **Wide range:** The new 3G Metric™ range is comprehensive: straight and reducing joiners, tees, elbows, end connectors and caps ranging from 20mm to 63mm.
- **Approvals:** Philmac fittings comply with AS/NZS 4129:2000 and are WRAS approved for above and below ground use.



1. Cut Pipe Square

Cut the pipe square. There is no need to prepare the pipe end. Chamfering or lubrication is not required.



2. Ready to Use Position

The fitting is pre-assembled and ready to use, however always ensure the nut is fully relaxed and 2 threads are showing before inserting the pipe.



3. Pipe Insertion

Insert the pipe until the first point of resistance is felt.



4. Nut Tightening

The nut should be tightened by hand and then firmly with a wrench. Tighten the nut all the way to the flange on the body of the fitting.



5. Fully Installed

Fitting is now fully installed.



6. Disassembly

To disassemble the fitting simply loosen the nut using a wrench until 2 threads are showing. Pipe will be released and can simply be pulled out of the fitting.

Note: Philmac recommends the use of PTFE tape on BSP threads to ensure a positive seal.

TAPPING SADDLES

Use

For use with metric PE, metric PP or metric ABS pipes.

Pre Assembly

Select branch off-take position, clean pipe, ensure access and mark hole. Place saddle upper body over pipe and align outlet branch with marked hole.

Assembly

Place saddle lower body over pipe. Tighten all bolts alternatively around saddle. Ensure saddle off-take hole stays in alignment with marked hole. Drill suitable sized hole through orifice of saddle with boring tool. Ensure not to damage threads and gasket.

Disassembly

Loosen and detach all bolts around saddle.

SYSTEM DESIGN CONSIDERATIONS

There are generally two types of PE pipe fittings; mechanical and thermofusion. Philmac 3G Metric™ is a range of mechanical fittings that offers three distinct advantages over thermofusion fittings;

- **More economical**
- **Quick and easy installation**
- **Quick and easy revision to installation**

This section highlights engineering considerations when designing a PE pipe system with Philmac 3G Metric™.

Projected life of Compression fittings

Whilst Philmac 3G Metric™ conforms to institutionalised specifications written to have a minimum life of 50 years, its compression fittings are intentionally developed to exceed the expectations of these specifications.

Head losses

The following table offers a guide in estimating head losses in PE pipe systems based on the conveyance of water.

Use the following formula to estimate this head loss;

$$L = F \times D$$

where **F** = fitting constant

D = pipe inner diameter (m)

L = head loss based on equivalent pipe length (m)

Fitting	Fitting Constant (F)
90° elbow	30
90° tee - straight through	12
90° tee - side branch	60

Resistance to Impact

The thermoplastic materials used in the Philmac 3G Metric™ fitting have excellent impact properties.

Abrasion Resistance

Philmac 3G Metric™ is suitable for the transportation of abrasive slurries and will withstand normal conditions found in urban, mining, industrial, rural water and waste water systems.

Weathering

The materials used contain pigments to provide excellent protection to degradation due to ultra-violet radiation. Continuous use of the Philmac 3G Metric™ fitting in systems above ground is therefore permissible without additional protection.

Electrolytic Corrosion

Philmac 3G Metric™ is non magnetising and does not cause electrolytic deterioration.

Thermal Insulation

Polypropylene has natural thermal insulation of 2000 times over copper and 200 times over steel.

Light Transmission

The all black Philmac 3G Metric™ does not transmit light, thus protecting the water quality in potable water pipelines from growth of micro organisms.

Effect on Water

Philmac 3G Metric™ does not impart to water any odour, taste, colour, or any constituents in concentrations that could be injurious to health.

Fluids other than Water

Philmac 3G Metric™ may convey a wide variety of fluids. The following table is provided as a guide only for the compatibility of various chemicals to Philmac 3G Metric™. Contact Marley Technical Services for advice on specific applications.

CHEMICAL RESISTANCE

Chemical	Satisfactory	Not Satisfactory
Air	▲	
Ammonium Hydroxide	▲	
Alcohol	▲	
Acetone		▲
Auto Transmission Fluid	▲	
Antifreeze	▲	
Benzene		▲
Butane	▲	
Calcium Salts	▲	
Caustic Soda (40% aqueous)	▲	
Cresol		▲
Citric Acid (10% aqueous)	▲	
Copper Salts	▲	
Ethylene Alcohol	▲	
Ethyl Glycol	▲	
Diesel	▲	
Formic Acid		▲
Gasoline		▲
Hydrochloric Acid		▲
Kerosene		▲
Mineral Oils	▲	
Methane	▲	
Methylene Chloride		▲
Nitric Acid		▲
Petroleum Oils	▲	
Sewerage	▲	
Sodium Cyanide	▲	
Sulphuric Acid		▲
Toluene		▲
Turpentine		▲
Transformer Oil	▲	
Zinc Salt Solution	▲	

Note: Fluid Temperature = 20°C

MATERIALS & COMPONENTS

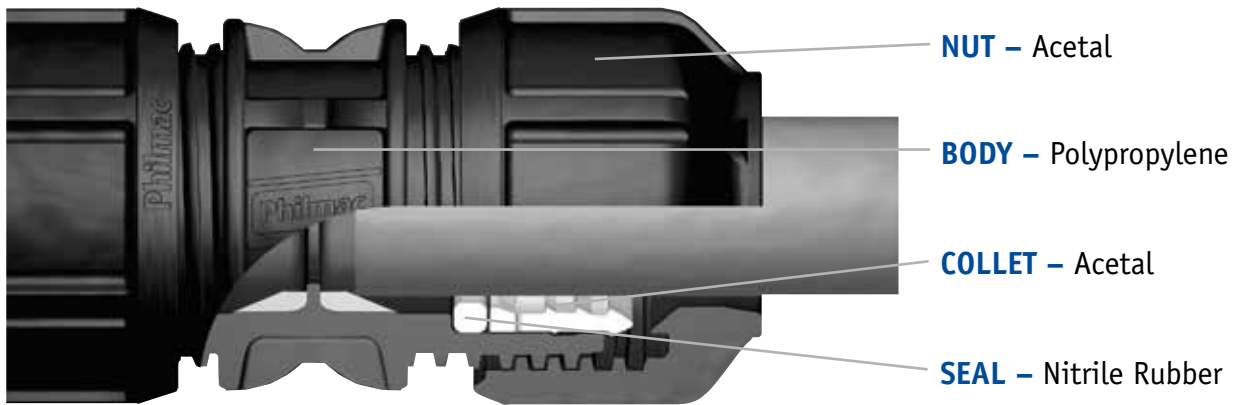

PRINCIPALS OF OPERATION

FULLY OPEN

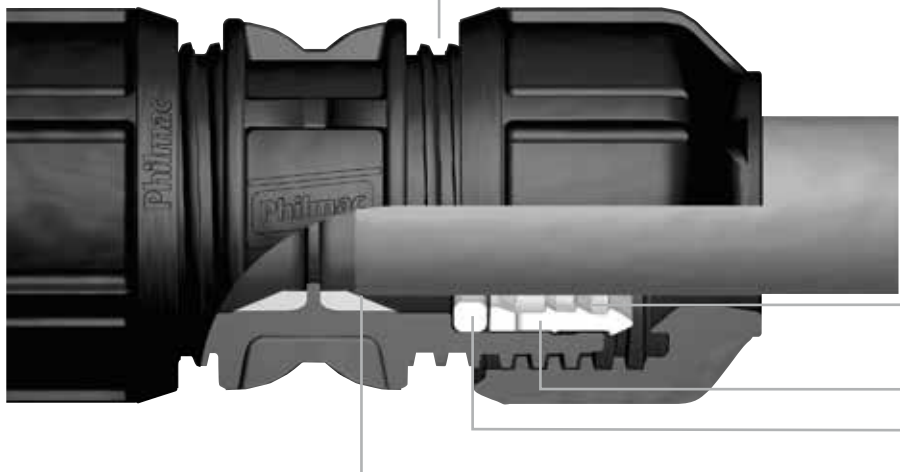

Fitting is pre-assembled ready to use in the open position with 2 threads showing.

Clearance between the pipe and fitting allows for easy insertion of the pipe.

Split collet, which is in relaxed position.

Seal, which is in relaxed position.

The pipe sits against the tapered wedges which minimises pipe rotation.

FULLY CLOSED



Split collet bites into the pipe providing end load resistance.

Positive internal stop when nut meets flange of the body.

Nut and then split collet has fully compressed the seal. Seal ring compression is achieved by exploiting the mechanical advantage of the nut thread.

Manufacturer Accreditation

Only fittings manufactured by Manufacturers with a Quality System approved to ISO9001 or equivalent shall be accepted for use.

Product Performance Accreditation

Fittings for Polyethylene (PE) pipes shall meet the applicable performance requirements of ISO14236 with specific reference to:

- a) Pressure Testing (ISO 3458)
- b) External Pressure resistance testing (ISO 3459)
- c) Resistance to pull out of test assemblies at 20° C (ISO 3501)
- d) Internal pressure resistance when subjected to bending stresses (ISO 3503)

Threaded ends of fittings shall be tapered and conform to BS21 (specification for pipe threads for tubes and fittings where pressure tight joints are made on threads).

Product Material Accreditation

Fittings for Polyethylene (PE) pipes shall be approved to ISO 9080 (Plastic piping and ducting systems – determination of the long term hydrostatic strength of thermoplastic materials in pipe form by extrapolation). Performance verification shall be according to test parameters outlined in Clause 8.3.2.2 of ISO 14236 – Verification of long term behaviour.

Fittings shall be suitable for the conveyance of drinking water and shall conform to BS6920 (suitability of non metallic products for use in contact with water intended for human consumption with regard to their effect on the quality of water).

Product Configuration/Material Overview

Fittings shall be compression fitting type.

Fitting bodies shall be of Polypropylene material, nuts shall be of Acetal material. Each fitting shall be supplied complete and pre assembled with captivated collet and seal ring.

Collets shall be in Acetal material and seal rings shall be made from nitrile rubber.

Fitting colour shall be black so as to minimise potential light transmission and/or UV degradation.

Method of Connection

The seal of a joint will be achieved by nut tightening so as to obtain watertightness by a seal ring around the external diameter of the pipe.

Any pipe preparation will be limited to cutting and cleaning of pipe (for foreign material or burrs). Fittings shall not require the pipe to be lubricated or chamfered during installation.

There shall be no loose components during assembly or disassembly (meaning that the fitting shall not be required to be dismantled during assembly or disassembly and if the nut is removed accidentally components will not fall out of the fitting unless removed deliberately).



JOINERS (METRIC X METRIC)

Size	Code	Dimensions mm.			kg.
		S	D	L	Wt
20 x 20	MM301.20	10	47	90	0.08
25 x 25	MM301.25	11	55	97	0.12
32 x 32	MM301.32	14	67	118	0.20
40 x 40	MM301.40	18	81	136	0.33
50 x 50	MM301.50	24	94	161	0.52
63 x 63	MM301.63	29	110	182	0.76

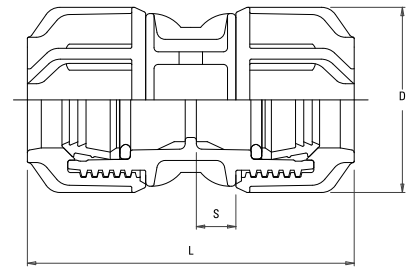

SLIP COUPLINGS (METRIC)

Size	Code	Dimensions mm.			kg.
		S	D	L	Wt
20	MM301.20S	10	47	90	0.08
25	MM301.25S	11	55	97	0.12
32	MM301.32S	14	67	118	0.20
40	MM301.40S	18	81	136	0.33
50	MM301.50S	24	94	161	0.52
63	MM301.63S	29	110	182	0.76

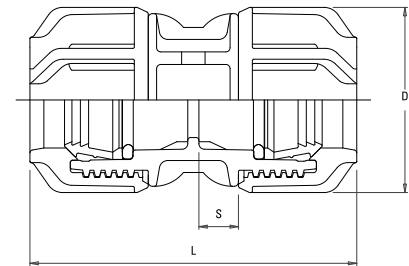

REDUCING JOINERS (METRIC X METRIC)

Size	Code	Dimensions mm.					kg.
		S	S1	D	D1	L	Wt
25 x 20	MM304.25.20	11	10	55	47	94	0.10
32 x 20	MM304.32.20	14	10	67	47	110	0.14
32 x 25	MM304.32.25	14	11	67	55	108	0.16
40 x 25	MM304.40.25	18	11	81	55	125	0.24
40 x 32	MM304.40.32	18	14	81	67	128	0.28
50 x 25	MM304.50.25	24	11	94	55	141	0.34
50 x 32	MM304.50.32	24	14	94	67	150	0.38
50 x 40	MM304.50.40	24	18	94	81	149	0.44
63 x 32	MM304.63.32	29	14	110	67	167	0.51
63 x 40	MM304.63.40	29	18	110	81	173	0.57
63 x 50	MM304.63.50	29	24	110	94	174	0.66

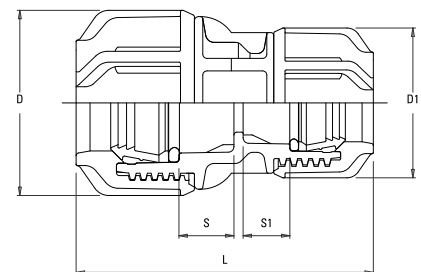

END CONNECTORS (METRIC X MI BSP)

Size	Code	Dimensions mm.				kg.
		S	D	L	T	
20 x 1/2"	MM302.20.15	17	47	73	19.8	0.05
20 x 3/4"	MM302.20.20	17	47	75	21.1	0.05
20 x 1"	MM302.20.25	17	47	78	24.4	0.05
25 x 1/2"	MM302.25.15	19	55	81	19.8	0.07
25 x 3/4"	MM302.25.20	19	55	82	21.1	0.07
25 x 1"	MM302.25.25	19	55	85	24.4	0.08
32 x 3/4"	MM302.32.20	22	67	91	21.1	0.12
32 x 1"	MM302.32.25	22	67	94	24.4	0.12
32 x 1-1/4"	MM302.32.32	22	67	97	26.7	0.13
32 x 1-1/2"	MM302.32.40	22	67	97	26.7	0.13
40 x 1"	MM302.40.25	28	81	106	24.4	0.20
40 x 1-1/4"	MM302.40.32	28	81	109	26.7	0.20
40 x 1-1/2"	MM302.40.40	28	81	109	26.7	0.20
40 x 2"	MM302.40.50	28	81	112	31	0.20
50 x 1-1/2"	MM302.50.40	30	94	118	26.7	0.30
50 x 2"	MM302.50.50	30	94	119	31	0.31
63 x 1-1/2"	MM302.63.40	36	110	132	26.7	0.40
63 x 2"	MM302.63.50	36	110	127	31	0.41

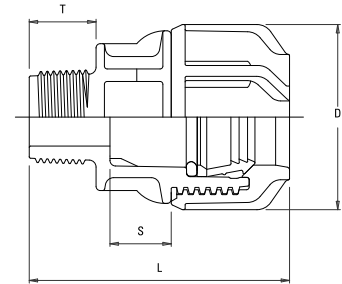

END CONNECTORS (METRIC X FI BSP)

Size	Code	Dimensions mm.				kg.
		S	D	L	T	
20 x 1/2"	MM303.20.15	10	47	71	22.8	0.05
20 x 3/4"	MM303.20.20	10	47	70	24.1	0.05
20 x 1"	MM303.20.25	10	47	73	27.4	0.05
25 x 1/2"	MM303.25.15	11	55	74	22.8	0.08
25 x 3/4"	MM303.25.20	11	55	71	24.1	0.08
25 x 1"	MM303.25.25	11	55	77	27.4	0.08
32 x 1"	MM303.32.25	14	67	88	27.4	0.13
40 x 1-1/4"	MM303.40.32	18	81	101	30.2	0.20
40 x 1-1/2"	MM303.40.40	18	81	101	30.2	0.21
50 x 1-1/2"	MM303.50.40	24	94	106	30.2	0.29
50 x 2"	MM303.50.50	24	94	107	34.5	0.30
63 x 2"	MM303.63.50	29	110	121	34.5	0.44

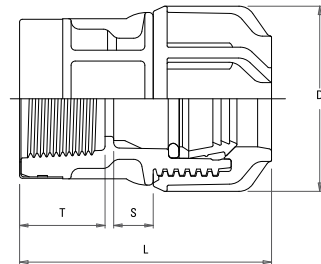

TEES (METRIC X METRIC X METRIC)

Size	Code	Dimensions mm.					kg.
		S	D	H	G	L	
20 x 20 x 20	MM305.20	10	47	59	31	117	0.12
25 x 25 x 25	MM305.25	11	55	67	40	134	0.19
32 x 32 x 32	MM305.32	14	67	80	48	160	0.33
40 x 40 x 40	MM305.40	18	81	95	50	182	0.53
50 x 50 x 50	MM305.50	24	94	101	60	202	0.80
63 x 63 x 63	MM305.63	29	110	118	73	236	1.22

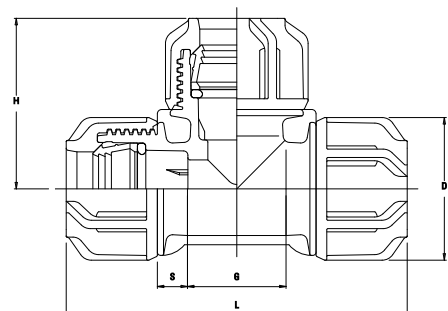

SLIP TEES (METRIC)

Size	Code	Dimensions mm.					kg.	
		S	D	H	G	L	Wt	
20 x 20 x 20	MM305.20S	10	47	59	31	117	0.12	
25 x 25 x 25	MM305.25S	11	55	67	40	134	0.19	
32 x 32 x 32	MM305.32S	14	67	80	48	160	0.33	
40 x 40 x 40	MM305.40S	18	81	95	50	182	0.53	
50 x 50 x 50	MM305.50S	24	94	101	60	202	0.80	
63 x 63 x 63	MM305.63S	29	110	118	73	236	1.22	

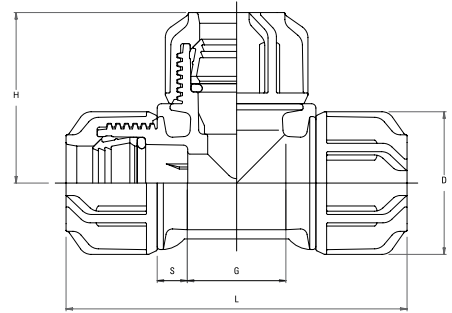

REDUCING TEES (METRIC X METRIC X METRIC)

Size	Code	Dimensions mm.							kg.	
		S	S1	D	D1	H	G	L	Wt	
25 x 25 x 20	MM305.25.20	11	10	55	47	64	40	134	0.18	
25 x 25 x 32	MM305.25.32	11	14	55	64	69	40	134	0.24	
32 x 32 x 25	MM305.32.25	14	11	67	55	74	40	160	0.30	
50 x 50 x 40	MM305.50.40	24	21	94	81	98	60	197	0.70	
63 x 63 x 50	MM305.63.50	29	24	110	94	111	73	220	1.05	

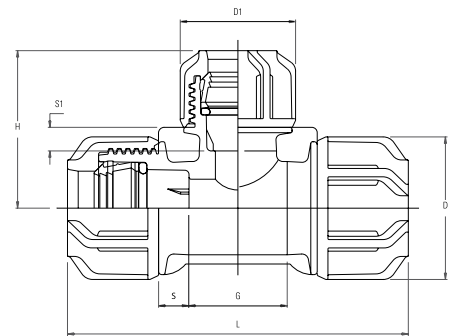

TEES (METRIC X METRIC X FI BSP)

Size	Code	Dimensions mm.						kg.	
		S	D	H	G	L	T	Wt	
20 x 20 x 1/2"	MM306.20.15	10	47	38	31	117	22.8	0.09	
20 x 20 x 3/4"	MM306.20.20	10	47	38	31	117	24.1	0.10	
25 x 25 x 1/2"	MM306.25.15	11	55	40	40	134	22.8	0.14	
25 x 25 x 3/4"	MM306.25.20	11	55	41	40	134	24.1	0.15	
25 x 25 x 1"	MM306.25.25	11	55	44	40	134	27.4	0.16	
32 x 32 x 3/4"	MM306.32.20	14	67	44	48	160	24.1	0.24	
32 x 32 x 1"	MM306.32.25	14	67	44	48	160	27.4	0.25	
32 x 32 x 1-1/4"	MM306.32.32	14	67	50	48	160	30.2	0.26	
40 x 40 x 1/2"	MM306.40.40	18	81	48	19	151	22.8	0.33	
40 x 40 x 1-1/4"	MM306.40.32	18	81	56	50	182	30.2	0.41	
50 x 50 x 1/2"	MM306.50.40	24	94	54	19	175	22.8	0.51	
50 x 50 x 1-1/2"	MM306.50.40	24	94	67	60	197	30.2	0.58	
50 x 50 x 2"	MM306.50.50	24	94	71	60	213	34.5	0.63	
63 x 63 x 2"	MM306.63.50	29	110	77	73	226	34.5	0.89	

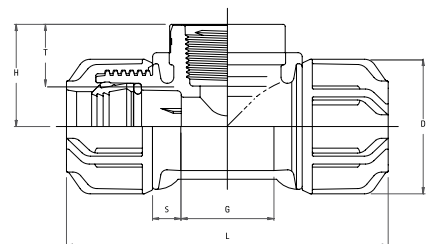

ELBOWS (METRIC X METRIC)

Size	Code	Dimensions mm.			kg.
		S	D	L	Wt
20 x 20	MM308.20	10	47	59	0.07
25 x 25	MM308.25	11	55	67	0.13
32 x 32	MM308.32	14	67	80	0.22
40 x 40	MM308.40	18	81	91	0.36
50 x 50	MM308.50	24	94	101	0.55
63 x 63	MM308.63	29	110	118	0.85

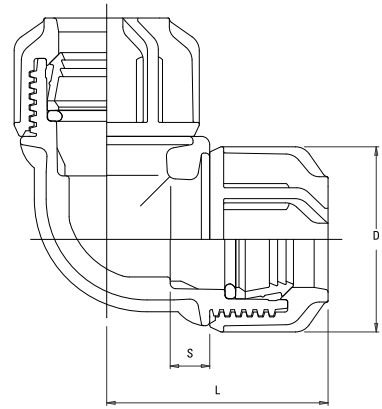

ELBOWS (METRIC X FI BSP)

Size	Code	Dimensions mm.					kg.
		S	D	H	L	T	Wt
20 x 1/2"	MM307.20.15	10	47	73	59	22.8	0.05
20 x 3/4"	MM307.20.20	10	47	73	59	24.1	0.06
25 x 1/2"	MM307.25.15	11	55	88	67	22.8	0.08
25 x 3/4"	MM307.25.20	11	55	88	67	24.1	0.08
25 x 1"	MM307.25.25	11	55	88	67	27.4	0.09
32 x 1"	MM307.32.25	14	67	105	80	27.4	0.14
32 x 1-1/4"	MM307.32.32	14	67	105	81	30.2	0.15
40 x 1-1/4"	MM307.40.32	18	81	126	91	30.2	0.23
40 x 1-1/2"	MM307.40.40	18	81	126	91	30.2	0.24
50 x 1-1/2"	MM307.50.40	24	94	142	101	30.2	0.33
50 x 2"	MM307.50.50	24	94	142	106	34.5	0.38
63 x 2"	MM307.63.50	29	110	160	113	34.5	0.53

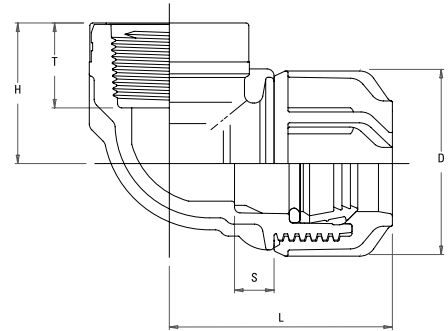

ELBOWS (METRIC X MI BSP)

Size	Code	Dimensions mm.					kg.
		S	D	H	L	T	Wt
25 x 3/4"	MM309.25	13	55	49	65	21.1	0.07
32 x 1"	MM309.32	14	67	68	69	24.1	0.07

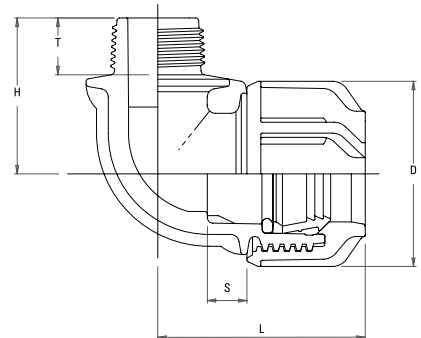

END CAPS (METRIC)

Size	Code	Dimensions mm.			kg.
		S	D	L	Wt
20	MM310.20	19	47	58	0.04
25	MM310.25	23	55	68	0.07
32	MM310.32	24	67	78	0.11
40	MM310.40	31	81	92	0.19
50	MM310.50	33	94	105	0.29
63	MM310.63	41	110	124	0.45

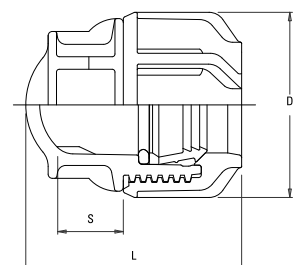

METRIC FITTINGS - 75-110mm range

JOINERS

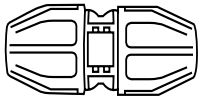

Code	Size
MM301.75	75 x 75
MM301.90	90 x 90
MM301.110	110 x 110

90° ELBOWS

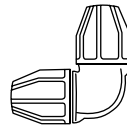

Code	Size
MM308.75	75 x 75
MM308.90	90 x 90
MM308.110	110 x 110

REDUCING JOINERS

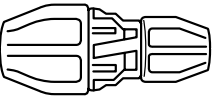

Code	Size
MM304.75.63	75 x 63
MM304.90.75	90 x 75
MM304.110.90	110 x 90

ELBOW FEMALE THREAD

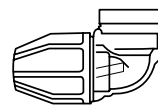

Code	Size
MM307.75.50	75 x 2"
MM307.90.75	90 x 3"
MM307.110.100	110 x 4"

MALE ADAPTER

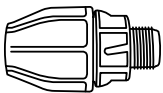

Code	Size
MM302.75.50	75 x 2"
MM302.75.75	75 x 3"
MM302.90.75	90 x 3"
MM302.110.100	110 x 4"

END CAPS

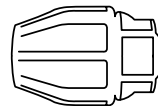

Code	Size
MM310.75	75
MM310.90	90
MM310.110	110

FEMALE ADAPTER

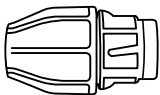

Code	Size
MM303.75.50	75 x 2"
MM303.90.75	90 x 3"
MM303.110.100	110 x 4"

TAPPING SADDLES METRIC

PE X FI BSP*

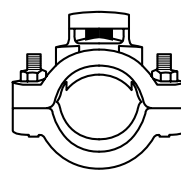

Code	Size
MM325.25.20	25 x 3/4"
MM325.32.20	32 x 3/4"
MM325.32.25	32 x 1"
MM325.40.20	40 x 3/4"
MM325.40.25	40 x 1"
MM325.50.20	50 x 3/4"
MM325.50.25	50 x 1"
MM325.63.20	63 x 3/4"
MM325.63.25	63 x 1"
MM325.63.40	63 x 1-1/2"
MM325.75.20	75 x 3/4"
MM325.75.25	75 x 1"
MM325.75.40	75 x 1-1/2"
MM325.75.50	75 x 2"
MM325.90.25	90 x 1"
MM325.90.40	90 x 1-1/2"
MM325.90.50	90 x 2"
MM325.110.25	110 x 1"
MM325.110.40	110 x 1-1/2"
MM325.110.50	110 x 2"

TEES

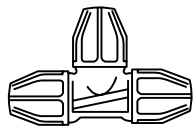

Code	Size
MM305.75	75 x 75 x 75
MM305.90	90 x 90 x 90
MM305.110	110 x 110 x 110

TEE FEMALE THREAD



Code	Size
MM306.75.50	75 x 75 x 2"
MM306.90.75	90 x 90 x 3"
MM306.110.100	110 x 110 x 4"

*Includes Stainless Steel Nuts & Bolts.

UNIVERSAL TRANSITION FITTINGS

Size	Code	Dimensions mm				kg.
		A	B	C	D	wt

COUPLING (POL X TRANSITION)

20 x 15-21	MM331.20.15.21	54	47	121	-	0.12
20 x 21-27	MM331.20.21.27	66	47	136	-	0.16
25 x 15-21	MM331.25.15.21	54	56	133	-	0.14
25 x 21-27	MM331.25.21.27	66	56	144	-	0.20
25 x 27-34	MM331.25.27.34	80	56	172	-	0.31
32 x 27-34	MM331.32.27.34	80	69	172	-	0.31
32 x 34-39	MM331.32.34.39	80	69	117	-	0.32
32 x 39-43	MM331.32.39.43	95	69	200	-	0.35
50 x 47-49	MM331.50.47.49	96	96	235	-	0.71
63 x 47-49	MM331.63.47.49	96	113	250	-	0.82
63 x 59-61	MM331.63.59.61	113	113	270	-	1.02

ELBOWS (POL X TRANSITION)

25 x 15-21	MM340.25.15.21	54	56	86	93	0.16
25 x 21-27	MM340.25.21.27	66	56	92	96	0.20
25 x 27-34	MM340.25.27.34	80	56	99	100	0.23
32 x 27-34	MM340.32.27.34	80	69	104	107	0.30

ELBOWS (TRANSITION X TRANSITION)

15-21 x 15-21	MM348.15.21	54	54	96	96	0.14
21-27 x 21-27	MM348.21.27	66	66	94	94	0.24

TEES (TRANSITION X TRANSITION)

15-21 x 15-21	MM349.15.21	171	54	86	-	0.22
---------------	-------------	-----	----	----	---	------

TEES (TRANSITION X FI BSP)

15-21 x 3/4"	MM350.15.20	171	54	38	-	0.17
15-21 x 1"	MM350.15.25	171	54	38	-	0.18
21-27 x 3/4"	MM350.21.20	198	66	40	-	0.26
21-27 x 1"	MM350.21.25	198	66	40	-	0.27

END CONNECTOR (MI BSP X TRANSITION)

3/4" x 15-21	MM341.20.15.21	97	54	-	-	0.08
3/4" x 21-27	MM341.20.21.27	107	66	-	-	0.13
3/4" x 27-34	MM341.20.27.34	119	80	-	-	0.20

DOUBLE ENDED COUPLING (TRANSITION X REDUCING TRANSITION)

21-27 x 15-21	MM345.21.15	143	66	54	-	0.18
27-34 x 21-27	MM345.27.21	168	80	66	-	0.28
27-34 x 15-21	MM345.27.15	163	80	54	-	0.24
39-43 x 27-34	MM345.39.27	185	96	80	-	0.43

DOUBLE ENDED COUPLING (TRANSITION X TRANSITION)

15-21 x 15-21	MM344.15.21	133	54	54	-	0.15
21-27 x 21-27	MM344.21.27	154	66	66	-	0.22
27-34 x 27-34	MM344.27.34	168	80	80	-	0.35
39-43 x 39-43	MM344.39.43	192	95	95	-	0.51
34-39 x 34-39	MM344.34.39	173	80	80	-	0.41
47-49 x 47-49	MM344.47.49	224	96	96	-	0.78
59-61 x 59-61	MM344.59.61	270	113	113	-	1.07

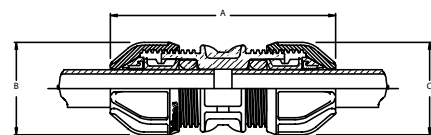
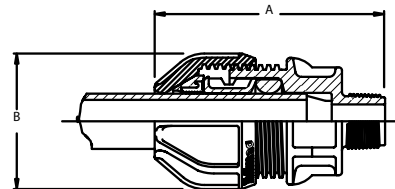
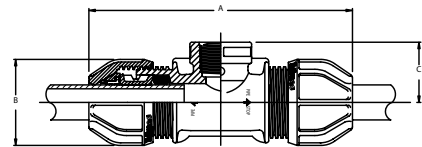
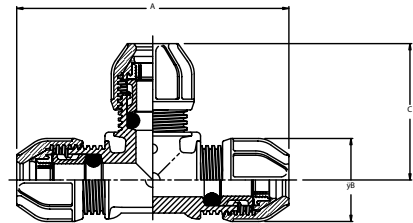
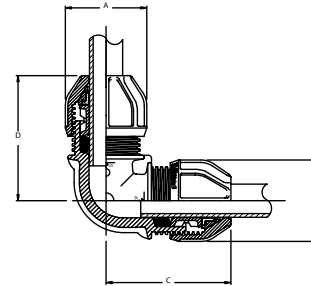
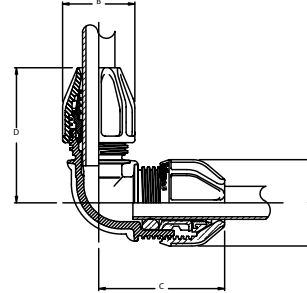
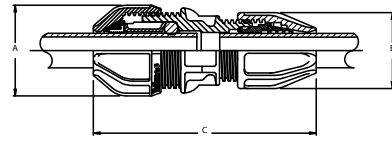

VALVES

TROUGH VALVE

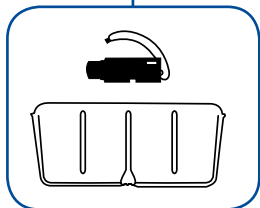

Code	Size
AQ 400 P	3/4" Plastic valve with float
AQ 500 P	1" Plastic valve with float

BALL VALVE FI X FI

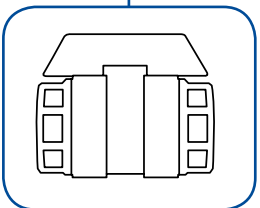

Code	Size
MM 15.BV	1/2" Ball valve FI x FI BSP
MM 20.BV	3/4" Ball valve FI x FI BSP
MM 25.BV	1" Ball valve FI x FI BSP
MM 32.BV	1 1/4" Ball valve FI x FI BSP
MM 40.BV	1 1/2" Ball valve FI x FI BSP
MM 50.BV	2" Ball valve FI x FI BSP

BALL VALVE POLY X POLY

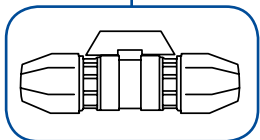

Code	Size
MM 20.BVPI	20/1/2" x 20/1/2"
MM 20.BVP2	20/3/4" x 20/3/4"
MM 25.BVP	25/3/4" x 25/3/4"
MM 32.BVP	32/1" x 32/1"

BALL VALVE MI X MI

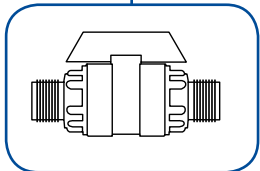

Code	Size
MM 20.BVMI	3/4" MI x 3/4" MI BSP
MM 25.BVMI	1" MI x 1" MI BSP

STOPCOCK POLY X POLY

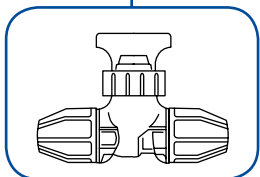

Code	Size
MM 20.SC	20 x 20
MM 25.SC	25 x 25
MM 32.SC	32 x 32

*Polyethylene end x MI BSP with non-return valve in body

FOOT VALVE FI

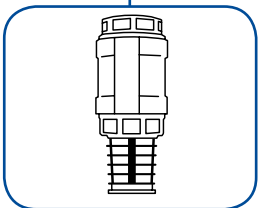

Code	Size
MM 20.FV	3/4" Foot valve FI BSP
MM 25.FV	1" Foot valve FI BSP
MM 32.FV	1 1/4" Foot valve FI BSP
MM 40.FV	1 1/2" Foot valve FI BSP
MM 50.FV	2" Foot valve FI BSP

AIR RELEASE VALVE FI

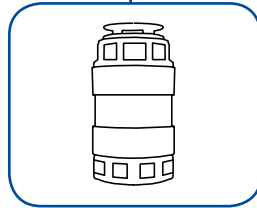

Code	Size
MM 25.AR.V	1" Air release valve FI BSP

BACK FLOW PREVENTION VALVES

DOUBLE CHECK VALVE

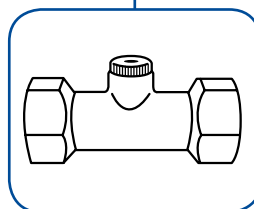

Code	Size
MM 20.DCV	3/4" Double check valve
MM 25.DCV	1" Double check valve

NON RETURN VALVE FI x FI

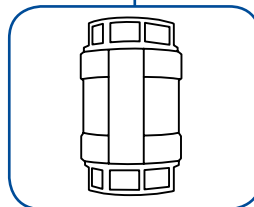

Code	Size
MM 20.NRV	3/4" Non return valve FI x FI BSP
MM 25.NRV	1" Non return valve FI x FI BSP
MM 32.NRV	1 1/4" Non return valve FI x FI BSP
MM 40.NRV	1 1/2" Non return valve FI x FI BSP
MM 50.NRV	2" Non return valve FI x FI BSP

THREADED FITTINGS

NIPPLE MI

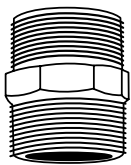

Code	Size
328.15	1/2"
328.20	3/4"
328.25	1"
328.32	1-1/4"
328.40	1-1/2"
328.50	2"

REDUCING NIPPLE MI

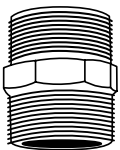

Code	Size
328.20.15	3/4" x 1/2"
328.25.15	1" x 1/2"
328.25.20	1" x 3/4"
328.32.20	1-1/4" x 3/4"
328.32.25	1-1/4" x 1"
328.40.25	1-1/2" x 1"
328.40.32	1-1/2" x 1-1/4"
328.50.25	2" x 1"
328.50.32	2" x 1-1/4"
328.50.40	2" x 1-1/2"

REDUCING BUSH FI/MI

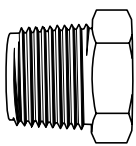

Code	Size
327.20.15	3/4" x 1/2"
327.25.15	1" x 1/2"
327.25.20	1" x 3/4"
327.32.20	1-1/4" x 3/4"
327.32.25	1-1/4" x 1"
327.40.20	1-1/2" x 3/4"
327.40.25	1-1/2" x 1"
327.40.32	1-1/2" x 1-1/4"
327.50.20	2" x 3/4"
327.50.25	2" x 1"
327.50.32	2" x 1-1/4"
327.50.40	2" x 1-1/2"

SOCKET FI/FI

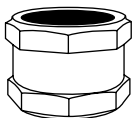

Code	Size
329.15	1/2"
329.20	3/4"
329.25	1"
329.32	1-1/4"
329.40	1-1/2"
329.50	2"

REDUCING SOCKET FI/FI

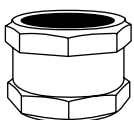

Code	Size
329.20.15	3/4" x 1/2"
329.25.15	1" x 1/2"
329.25.20	1" x 3/4"
329.32.20	1-1/4" x 3/4"
329.32.25	1-1/4" x 1"
329.40.25	1-1/2" x 1"
329.40.32	1-1/2" x 1-1/4"
329.50.25	2" x 1"
329.50.32	2" x 1-1/4"
329.50.40	2" x 1-1/2"

TEE FI

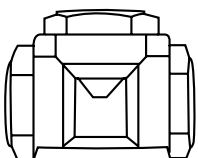

Code	Size
332.15	1/2"
332.20	3/4"
332.25	1"
332.32	1-1/4"
332.40	1-1/2"
332.50	2"

ELBOW FI/MI

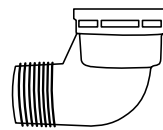

Code	Size
333.15	1/2"
333.20	3/4"
333.25	1"
333.32	1-1/4"
333.40	1-1/2"
333.50	2"

ELBOW FI/MI

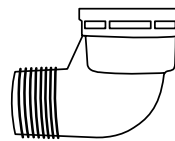

Code	Size
336.15	1/2"
336.20	3/4"
336.25	1"

PLUG MI

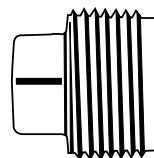

Code	Size
334.15	1/2"
334.20	3/4"
334.25	1"
334.32	1-1/4"
334.40	1-1/2"
334.50	2"

CAP FI



Code	Size
335.15	1/2"
335.20	3/4"
335.25	1"
335.32	1-1/4"
335.40	1-1/2"
335.50	2"

ACCESSORIES

METRIC SPANNERS

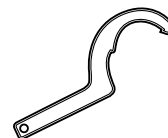

Code	Size
MM343.20.32	20-32
MM343.32.63	32-63
MM343.50.110	50-110

PIPE LINERS

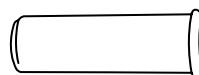

Code	Size
MM342.20	20
MM342.25	25
MM342.32	32
MM342.50	50
MM342.63	63



DISCLAIMER

This technical catalogue has been compiled by Marley New Zealand Limited ("The Company") to promote better understanding of the technical aspects of the Company's products to assist users in obtaining from them the best possible performance. The technical catalogue is supplied subject to acknowledgment of the following conditions:

The technical catalogue is protected by Copyright and may not be copied or reproduced in any form or by any means in whole or in part without prior consent in writing by the Company.

Product specifications, usage data and advisory information may change from time to time with advances in research and field experience. The Company reserves the right to make such changes at any time without notice.

Correct usage of the Company's products involve engineering judgements which cannot be properly made without full knowledge of all the conditions pertaining to each specific installation. The Company expressly disclaims all and any liability to any person whether supplied with this publication or not in respect of anything and of the consequences of anything done or omitted to be done by any such person in reliance whether whole or partial upon the whole or any part of the contents of this publication.

No offer to trade, nor any conditions of trading, are expressed or implied by the issue or content of this manual.

Nothing herein shall override the Company's Conditions of Sale, which may be obtained from the Registered Office or any Sales Office of the Company.

This technical catalogue is and shall remain the property of the Company, and shall be surrendered on demand to the Company.

AUCKLAND

Mahia Road, Manurewa, Private Bag 802 Manurewa
 Sales Department: Telephone 09 279 2777
 Direct Fax 09 279 2778 Freefax 0800 652 621
 Head Office: Telephone 09 279 2799 Fax 09 279 2798
 Sales Hotline: 0800 222 922

CHRISTCHURCH

Shands Road, Hornby, PO Box 16233 Christchurch
 Sales Hotline: 0800 222 922
 For more information call free
0800 MARLEY (0800 627 539)



For further information: **0800 MARLEY (0800 627 539)** www.marley.co.nz

an *Aliaxis* company

www.marley.co.nz

