

RURAL CATALOGUE 2008



MAGNUM
SPOUTING

Pg14

OASIS METRIC,
VALVES,
TRANSITION
& THREADED
FITTINGS

Pg5

RAINHARVESTING

Pg15

OASIS

Pg1



AGRIDUCT
CULVERT PIPE

Pg8

EFFLUENT
& CAMLOCK
FITTINGS

Pg13

ENDUROFLEX2

Pg3

DRAINFLO

Pg9

PVC IRRIGATION

Pg7

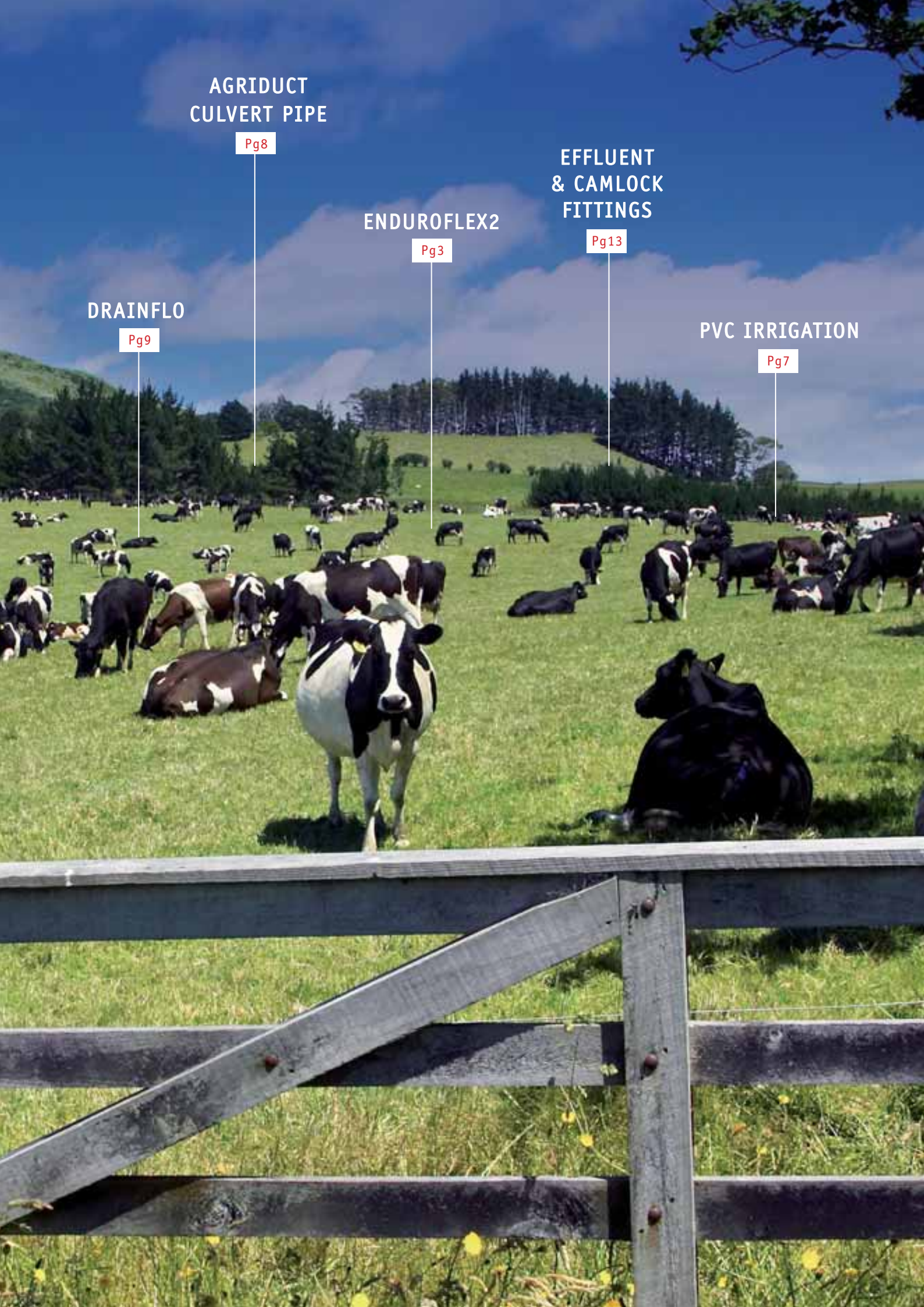

OASIS 6 BAR AND 9 BAR

Oasis has been specifically engineered by Marley using the very latest materials and technology to meet the high demands of modern large herd farming where breakdowns and average performance is not acceptable. Oasis is the ideal product in a farm conversion situation.

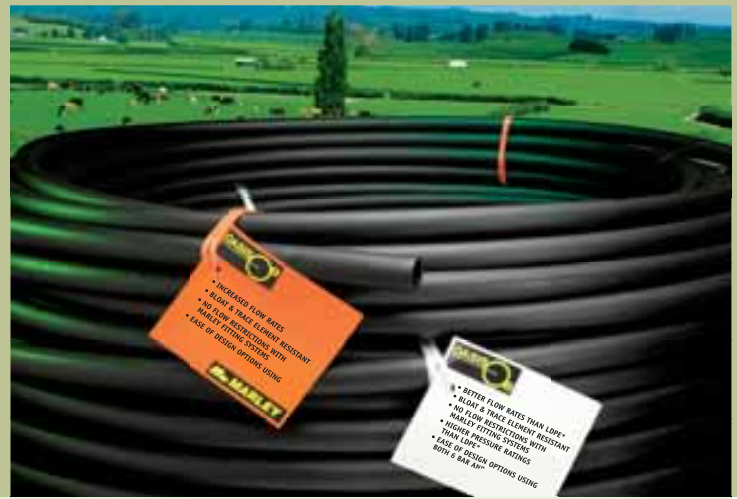

FITTING COMPATIBILITY

Oasis 6 bar and 9 bar are both compatible with Marley's advanced range of fitting systems which offer a full range of options plus one fitting for both pressure ratings. Whilst Oasis 6 bar and 9 bar can be used with all OD fittings currently sold it has been engineered to provide the best performance when used with Marley's range of fitting systems.

IMPROVED FLOW RATES

Oasis 6 bar when compared to LDPE* has between 38% and 132% better flow rates depending on pipe dimension (refer table). Oasis 9 bar when compared with other 9 bar rated pipe has between 8% and 18% better flow rates (refer table).

SUPERIOR FITTING SYSTEMS WITH LESS RESTRICTIONS

Marley's fitting systems offer less flow restrictions and a more secure fit than internal LDPE* fittings. Whilst Oasis is compatible with any Metric fittings, Marley recommend that for the best performance Oasis 6 bar and 9 bar be used with Marley's range of fitting systems.

HIGHER PRESSURE RATING

Oasis has a higher pressure rating than LDPE*. This allows Oasis to be used in a wider range of applications, especially with large dairy herds where higher flow and pressure ratings are required.

BLOAT TRACE ELEMENT RESISTANCE

Oasis is suitable for use with active bloat treatments in the water system in accordance with ASTM.D.1693 condition C.

EASE OF DESIGN OPTION USING BOTH OASIS 6 BAR AND 9 BAR SYSTEMS

Oasis has been designed to provide the same flow rates with both 6 bar and 9 bar. This enables a simpler design process when combining both pressure ratings in one water supply system.

FLOW RATE COMPARISONS

Oasis 6 Bar

63mm	OASIS delivers	1800 Lt/hr	(38%)	extra over 50mm LDPE
50mm	OASIS delivers	1290 Lt/hr	(63%)	extra over 40mm LDPE
40mm	OASIS delivers	540 Lt/hr	(42%)	extra over 32mm LDPE
32mm	OASIS delivers	280 Lt/hr	(42%)	extra over 25mm LDPE
25mm	OASIS delivers	160 Lt/hr	(56%)	extra over 20mm LDPE
20mm	OASIS delivers	130 Lt/hr	(132%)	extra over 15mm LDPE

Oasis 9 Bar

63mm	OASIS delivers	720 Lt/hr	(13%)	extra over 63mm 9 Ag Pipe
50mm	OASIS delivers	360 Lt/hr	(12%)	extra over 50mm 9 Ag Pipe
40mm	OASIS delivers	215 Lt/hr	(13%)	extra over 40mm 9 Ag Pipe
32mm	OASIS delivers	145 Lt/hr	(18%)	extra over 32mm 9 Ag Pipe
25mm	OASIS delivers	36 Lt/hr	(8%)	extra over 25mm 9 Ag Pipe
20mm	OASIS delivers	50 Lt/hr	(16%)	extra over 20mm 9 Ag Pipe

Note: Figures above based on Hydraulic Gradient of 1 metre/100 metres
*LDPE to NZ Standard 7601

DIMENSIONS AND PRESSURE RATINGS

Oasis 6 Bar

OD (mm)	Maximum Pressure Rating (bar)	Coil Sizes (m)
300-25	9	50,100,200
300-32	6	50,100,200
300-40	6	50,100,200
300-50	6	50,100,200
300-63	6	50,100,200

Oasis 9 Bar

OD (mm)	Maximum Pressure Rating (bar)	Coil Sizes (m)
300-25	9	50,100,200
300-32	9	50,100,200
300-40	9	50,100,200
300-50	9	50,100,200
300-63	9	50,100,200

Note: 1 bar = 14.5 PSI







DESIGN INFORMATION

PIPE SELECTION

Oasis is a specialty pipe designed to supply water in a farm conversion situation. The first consideration in planning a water supply is to decide: (a) Where the pipeline will be situated. (b) How much water will be required for the total 24 hour period.

The table below outlines the amount of water you will need and allows for wastage and hot weather evaporation.

Approximate 24 hour water consumption

One person		= 182 litres/24 hours
One milking cow		= 140 litres/24 hours
One dry cow or steer		= 45 litres/24 hours
One horse		= 54 litres/24 hours
One ewe in milk		= 15 litres/24 hours
One dry sheep		= 7 litres/24 hours

*Water consumption rates allow for all general household water consumption and include water used for farm/milk shed cleaning.

To select the correct diameter of pipe for a water system, the following points must be established:

1. Volume of water required at peak period.
2. Length of pipe required.
3. In the case of a gravity supply system the static pressure that is required. This can be determined by establishing the height of the water source.
4. In the case of a pumped system the maximum pumped pressure and flow rate will need to be determined.

*Maximum pressure in the pipe must not exceed working pressure.



Refer to page 16 for flow chart information.

INSTALLATION INSTRUCTIONS

EXPANSION AND CONTRACTION:

Polyethylene has a relatively high co-efficient of expansion, expanding 2mm per lineal metre of pipe with every 10°C increase in pipe material temperature. In above ground installations where the pipe is not fixed and allowed to 'snake', the expansion will be taken up by the flexibility of the pipeline system. When Polyethylene pipe is buried no allowance for expansion and contraction is normally required if the pipeline is permitted to return to normal operating temperature prior to final connection and backfilling.

MAXIMUM FLOW:

The flow through Oasis will in normal circumstances remain constant throughout the life of the pipeline.

CORROSION RESISTANCE:

Oasis is resistant to most forms of chemical attack. It is unaffected by aggressive water or ground conditions and is not subject to electrolytic corrosion.

However, where aggressive chemicals are to be conveyed the suitability for use should be checked against the chemical resistance tables in the Marley Pressure Pipelines Manual.

WATER HAMMER:

Sudden closure or opening of valves in pipelines results in a pressure surge (or 'water hammer'). Valves should therefore be opened and closed slowly.

ABOVE GROUND PIPELINES:

Where Oasis is laid above ground, it is essential to ensure that the pipes are adequately protected from damage by stock and vehicles. Keep pipes away from sharp edges where abrasive action could occur, due to expansion and contraction of pipe, particularly during hot weather. Ensure the pipe has freedom of movement, and if secured to fences the method of clipping should be such that the pipe can move freely when necessary.

It is recommended that where possible, large bore pipe lines are protected from direct sunlight and are buried.

BURIED PIPELINES:

Below ground installations should have a minimum cover of 300mm and a greater cover in trafficked areas. Bedding material must not contain any sharp objects such as stones as these can cause indentations and scoring of the pipe. Care should be taken to remove all levelling pegs or temporary packing before the commencement of pipe laying.

PLOUGHING IN:

Oasis can be ploughed directly into the ground using a pipe laying plough. The pipe must be stationary in relation to the surrounding soil and special care should be taken that the pipe is not subjected to excessive tension during or after the laying operation. The pipe should be inspected to ensure that it is not being scored by the machine. Soils with sharp stones are considered unsuitable for ploughing in techniques.

ENDUROFLEX2

EnduroFlex2 has been re-engineered with an improved compound and revised wall dimensions to take the lead in advanced product development in its class.

As a proven performer in the stock water reticulation market, EnduroFlex2 is becoming the preferred choice in its market sector.



FITTINGS COMPATIBILITY

EnduroFlex2 has been specifically re-engineered in conjunction with Hansen to provide superior fitting grip across the entire Hansen fittings range. Marley recommend that only Hansen fittings be used with EnduroFlex2 to ensure the very best performance.

IMPROVED U.V. RESISTANCE

EnduroFlex2 has extra U.V. inhibitors to give superior protection from sunlight when installed above the ground.

HIGHER PRESSURE RATING

EnduroFlex2 has higher pressure ratings than LDPE across all diameters. This allows EnduroFlex2 to be used in a wider range of applications, especially with large dairy herds where higher flow and pressure ratings are required.

BLOAT RESISTANT

EnduroFlex2 is suitable for use with active bloat treatments in the water system in accordance with ASTM.D.1693 condition C.

RESISTANCE TO TRACE ELEMENTS

EnduroFlex2 is resistant to common trace elements such as magnesium, copper and zinc and is ideally suited for use with Dosatron inline water medication systems where bloat treatments and trace elements are used.

GREATER FLEXIBILITY

EnduroFlex2 has greater flexibility (bending radius) than LDPE.

Bending Radius

Nominal Diameter (mm)	Enduroflex2 (mm)	LDPE (mm)
15	150	330
20	250	440
25	350	550
32	680	704
40	800	880
50	1050	1100

Pressure Rating Comparisons at 20°C

Nominal Diameter (mm)	Enduroflex2		LDPE	
	m/head	PSI	m/head	PSI
15	100	145	90	128
20	90	128	80	116
25	80	116	65	92
32	80	116	50	70
40	70	100	45	64
50	70	100	35	50

Dimensions

Nominal Diameter (mm)	Mean Inside Diameter (mm)	Coil Sizes (m)
900-15	12.85	25,50,100,200
900-20	18.90	25,50,100,200
900-25	25.40	25,50,100,200
900-32	32.00	50,100,200
900-40	37.80	50,100,200
900-50	50.40	50,100

In order to obtain maximum efficiency for your EnduroFlex2 Pipeline, any installation must be properly planned. Therefore, you are strongly advised to make your water requirement estimates as accurate as possible.









DESIGN INFORMATION

PIPE SELECTION

The first consideration in planning a piped water supply is to decide: (a) Where the pipeline will be situated. (b) For what purpose the water is required. (c) How much water will be required for the total 24 hour period.

The table below outlines the amount of water you will need and allows for wastage and hot weather evaporation.

Approximate 24 hour water consumption

One person		= 182 litres/24 hours
One milking cow		= 140 litres/24 hours
One dry cow or steer		= 45 litres/24 hours
One horse		= 54 litres/24 hours
One ewe in milk		= 15 litres/24 hours
One dry sheep		= 7 litres/24 hours

* Water consumption rates allow for all general household water consumption and include water used for farm/milk shed cleaning.

To select the correct diameter of pipe for a water system, the following three points must be established:

1. Volume of water required at peak period.
2. Length of pipe required.
3. Static pressure at outlet available to supply water.
*Maximum pressure in the pipe must NOT exceed working pressure.
4. In the case of a pumped system the maximum pumped pressure and flow rate will need to be determined.



Refer to page 17 for flow chart information.

INSTALLATION INSTRUCTIONS

EXPANSION AND CONTRACTION

Polyethylene has a relatively high co-efficient of expansion, expanding 2mm per lineal metre of pipe with every 10° C increase in pipe material temperature. In above ground installations where the pipe is not fixed and allowed to 'snake', the expansion will be taken up by the flexibility of the pipeline system. When Polyethylene pipe is buried no allowance for expansion and contraction is normally required if the pipeline is permitted to return to normal operating temperature prior to final connection and backfilling.

MAXIMUM FLOW:

The flow through Marley EnduroFlex2 will in normal circumstances remain constant throughout the life of the pipeline.

CORROSION RESISTANCE:

Marley EnduroFlex2 is resistant to most forms of chemical attack. It is unaffected by aggressive water or ground conditions and is not subject to electrolytic corrosion.

However, where aggressive chemicals are to be conveyed the suitability for use should be checked against the Chemical Resistance tables in the Marley Pressure Pipelines Manual.

WATER HAMMER:

Moving liquids in pipelines induce kinetic energy due to the mass and velocity of the liquid flow. Sudden closure or opening of valves in pipelines results in a pressure surge (or 'water hammer') being created as kinetic energy and is converted into pressure energy.

Valves should therefore be opened and closed slowly on all but short, small diameter pipelines.

ABOVE GROUND PIPELINES:

Where Marley EnduroFlex2 is laid above ground, it is essential to ensure that the pipes are adequately protected from damage by stock and vehicles. Keep pipes away from sharp edges where abrasive action could occur, due to expansion and contraction of pipe, particularly during hot weather. Ensure the pipe has freedom of movement, and if secured to fences the method of clipping should be such that the pipe can move freely when necessary.

More care is necessary when pipelines above 25mm diameter are exposed. This is due to the larger area of pipe exposed to direct sunlight which results in high heat absorption with consequent rise in temperature of the exposed surface. Being a poor thermal conductor, the increase in temperature tends to be localised. While the surface away from the sun remains cool the exposed surface could reach temperatures in excess of 93°C. These temperature differences, combined with the expansion of the pipe cause very severe stresses, leading to an ultimate risk of cracking or fracture. This could be further aggravated in cases where hot fluids are passing through the pipe. The combination of direct sunlight and high fluid temperature will cause expansion to take place, resulting in the pipe bending towards the sunlight. If the pipeline is under pressure this bending is aggravated, due to reduced tensile strength on the sunlight side of the pipe.

OASIS METRIC, VALVES, TRANSITION & THREADED FITTINGS

Designed to make the job at hand so much easier, these innovative plastic compression fittings are the culmination of years of exhaustive research and development and the utilisation of cutting edge manufacturing technology.



FAST AND EASY INSTALLATION

Slide & Tighten™ technology: Oasis Metric™ Fittings incorporate all the benefits of the Oasis unique Slide & Tighten™ technology. No pipe preparation is needed and no force is required to push the pipe past the seal, so installation couldn't be faster or easier. Simply insert the pipe into the fitting until the first point of resistance is felt, and then tighten the nut. Assembly is so easy you can even do it under live conditions. No special tools are required, and there is no need to disassemble the fitting before use because the Oasis Metric™ Fitting is supplied pre-assembled and ready to use.

Compact design: The size of the new Oasis Metric™ Fitting has been kept to a minimum, making the fitting ideal to use in confined areas. In addition to making connections with minimal turns of the nut, the design and size of the fitting means that in installations taking place between two fixed points, the manipulation of the pipe into the fitting becomes easy.

Easy disassembly: The fitting has been designed so the split collet is released as soon as the nut is backed off, making disassembly easy.

COMPLETE SECURITY

Dynamic sealing method: The mechanical advantage of the nut thread compresses the seal into position, eliminating resistance when inserting the pipe into the fitting so there is no risk of seal distortion or displacement.

Visual stop: The flange on the body of the Oasis Metric™ Fitting provides a visual stop to indicate when the nut is fully tightened. This removes any uncertainty from the installation process.

No loose components: If the nut is removed there is no danger of losing components, as the collet and seal ring are retained in the body of the fitting. Losing components in the trench becomes a thing of the past.

Designed to minimise pipe twist: The fitting has been designed to minimise pipe twist as the nut is tightened. Maximum pipe twist is approximately a quarter turn compared to one and a half turns with many other fittings. Pipe twist can impact on not only the connection you have just made but also on the connection at the other end of the line.

HIGH PERFORMANCE

Made from advanced thermoplastic materials: Oasis Metric™ Fittings are manufactured from lightweight high performance thermoplastic materials with outstanding impact, UV, chemical and corrosion resistance. The material is non-toxic and taint-free.

Rated to 1600 kPa: Oasis Metric™ Fittings are pressure rated to 1600 kPa (PN16) to meet the needs of high pressure systems. **50 year+ design life:** Built to withstand the toughest conditions to ensure longevity and durability, Oasis Metric™ Fittings have a 50 year+ design life.

COMPLETE COVERAGE

Wide range: The new Oasis Metric™ Fittings range is comprehensive: straight and reducing joiners, tees, elbows, end connectors and caps ranging from 20mm to 63mm.

Approvals: Oasis Metric™ Fittings comply with AS/NZS 4129:2000 and are WRAS approved for above and below ground use.

PRODUCT RANGE

POLYETHYLENE COMPRESSION FITTINGS

OASIS METRIC FITTINGS

Code	Description	20	25	32	40	50	63	75	90	110
MM301	Joiner	✓	✓	✓	✓	✓	✓	✓	✓	✓
MM301	Slip Coupler	✓	✓	✓	✓	✓	✓	-	-	-
MM304	Reducing Joiner	✓	✓	✓	✓	✓	✓	✓	✓	✓
MM302	Male Adaptor	✓	✓	✓	✓	✓	✓	✓	✓	✓
MM303	Female Adaptor	✓	✓	✓	✓	✓	✓	✓	✓	✓
MM311	Flange Adaptor	-	-	-	-	✓	✓	-	✓	✓
MM305	Tee	✓	✓	✓	✓	✓	✓	✓	✓	✓
MM305	Reducing Tee	✓	✓	✓	✓	✓	✓	-	-	-
MM306	Tee F Thread	✓	✓	✓	✓	✓	✓	✓	✓	✓
MM346	Tee M Thread	✓	✓	-	-	-	-	-	-	-
MM305	Slip Tee	✓	✓	✓	✓	✓	✓	-	-	-
MM308	Elbow 90°	✓	✓	✓	✓	✓	✓	✓	✓	✓
MM347	Elbow 45°	✓	✓	✓	-	-	-	-	-	-
MM307	Elbow F Thread	✓	✓	✓	✓	✓	✓	✓	✓	✓
MM309	Elbow M Thread	-	✓	✓	-	-	-	-	-	-
MM310	End Cap	✓	✓	✓	✓	✓	✓	✓	✓	✓

VALVES

	Code	Description
Trough Valves	AQ 400 P	¾" Plastic valve with float
	AQ 500 P	1" Plastic valve with float
Ball Valve FI x FI	MM 15.BV	½" Ball valve FI x FI BSP
	MM 20.BV	¾" Ball valve FI x FI BSP
	MM 25.BV	1" Ball valve FI x FI BSP
	MM 32.BV	1¼" Ball valve FI x FI BSP
	MM 40.BV	1½" Ball valve FI x FI BSP
	MM 50.BV	2" Ball valve FI x FI BSP

Note: BSP are imperial sized to suit standard connections.

TRANSITION FITTINGS

A unique range of transition fittings (PN 12 bar max) for connections:

From	To
Polyethylene	Copper, Lead, U-PVC, PE, LDPE, HDPE and combination of the above

TAPPING SADDLES

For use with metric PE, metric PP or metric ABS pipes.

PRE-ASSEMBLY

Select branch off-take position, clean pipe, ensure access and mark hole. Place saddle upper body over pipe and align outlet branch with marked hole.

ASSEMBLY

Place saddle lower body over pipe. Tighten all bolts around saddle. Ensure saddle off-take hole stays in alignment with marked hole. Drill suitable sized hole through orifice of saddle with boring tool. Ensure not to damage threads and gasket.

DISASSEMBLY

Loosen and detach all bolts around saddle.

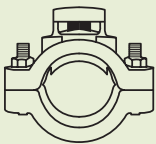

From	To
25mm x ¾" BSP	110mm x 2" BSP

INSTALLATION INSTRUCTIONS



1. CUT PIPE SQUARE

Cut the pipe square. There is no need to prepare the pipe end. Chamfering or lubrication is not required.

2. READY TO USE POSITION

The fitting is pre-assembled and ready to use, however always ensure the nut is fully relaxed and 2 threads are showing before inserting the pipe.

3. PIPE INSERTION

Insert the pipe until the first point of resistance is felt.



4. NUT TIGHTENING

The nut should be tightened by hand and then firmly with a wrench. Tighten the nut all the way to the flange on the body of the fitting.

5. FULLY INSTALLED

Fitting is now fully installed.

6. DISASSEMBLY

To disassemble the fitting simply loosen the nut using a wrench until 2 threads are showing. Pipe will be released and can simply be pulled out of the fitting.

Note: Marley recommends the use of PTFE tape on BSP threads to ensure a positive seal.

THREADED FITTINGS

NIPPLE MI
328

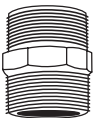

TEE FI
332



REDUCING NIPPLE MI
328

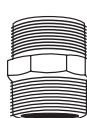

ELBOW FI/FI
333

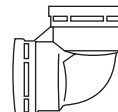

REDUCING BUSH FI/MI
327

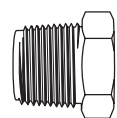

REDUCING SOCKET FI/FI
329



PLUG MI
334

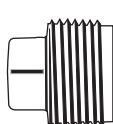

SOCKET FI/FI
329

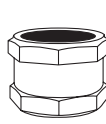

CAP FI
335



ELBOW MI/FI
336

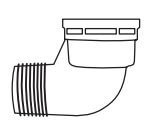

PVC – IRRIGATION PRESSURE SYSTEMS

U-PVC (Unplasticised) and M-PVC (Modified) pressure pipe systems are supplied into the Irrigation Market throughout New Zealand.



These pressure pipe systems consist of a wide range of pipes and fittings, rubber ring (RRJ) or solvent joints (SJ) and the pressure rating range from PN 6 to PN 18. All are produced in accordance with AS/NZS 1477 for U-PVC and AS/NZS 4765 for M-PVC pipes.

PVC PIPES – PRODUCT RANGE

U-PVC WHITE PRESSURE PIPE – 800 SERIES

Series 1; 6m effective lengths; AS/NZS 1477

Nominal 10mm	PN6	PN9	PN12	PN15	PN18
15	-	-	-	✓	✓
20	-	-	-	✓	✓
25	-	-	-	✓	✓
32	-	-	✓	✓	✓
40	✓	✓	✓	✓	✓
50	✓	✓	✓	✓	✓
65	✓	✓	✓	✓	✓
80	✓	✓	✓	✓	✓
100	✓	✓	✓	✓	✓
125	✓	✓	✓	✓	✓
200	✓	✓	✓	✓	✓
225	✓	✓	✓	✓	✓
250	✓	✓	✓	✓	✓
300	✓	✓	✓	✓	✓
375	✓	✓	✓	✓	✓

M-PVC WHITE PRESSURE PIPE – 850 SERIES

Series 1; 6m effective lengths; AS/NZS 4765

Nominal 10mm	PN9	PN12	PN15	PN18
100	✓	✓	✓	✓
125	✓	✓	✓	✓
150	✓	✓	✓	✓
175	✓	✓	✓	✓
200	✓	✓	✓	✓
225	✓	✓	✓	✓
250	✓	✓	✓	✓
300	✓	✓	✓	✓
375	✓	✓	✓	✓

U-PVC PRESSURE FITTINGS

Pressure fittings are manufactured in accordance with AS/NZS 1477 to pressure class PN 15. However, certain exceptions apply to individual fittings, particularly to some fittings which are sourced internationally. Before any installation takes place the PN pressure ratings must be checked on all fittings. In general, the following PN rating specifications apply;

Size range (mm)	PN (bar)	kPa	psi
15 -50	15	1500	217
65	12	1200	173
80-125	15	1500	217
150-200	12	1200	173
225-300	6	600	87

PVC PIPES – JOINTING SYSTEMS

1. Rubber Ring Joint (“Z” Joint)

A rubber ring joint system provides a flexible joint with the capability of axial and angular movement. Simple, error free installation makes these joints suited to larger diameters of PVC pipe, 50mm and larger.

2. Solvent Cement Joint

Solvent cement joint is a chemically “welded” joint with the capability of supporting the axial thrust. Available in sizes to 300mm, is especially suited to a smaller diameter system.

PVC PRESSURE PIPE – DESIGN & INSTALLATION

- PVC pressure pipelines shall be designed by appropriately trained, credited or licensed bodies/engineers.
- Further technical details and properties of U-PVC and M-PVC pressure pipes are available from Marley New Zealand – Pressure Technical Manual.
- The design and installation of PVC pressure pipe should comply with relevant AS/NZS standards :
 - AS/NZS 2032 – Installation of PVC pipe systems.
 - AS/NZS 2566 – Buried flexible pipelines.

AGRIDUCT CULVERT PIPE

Agriduct is Marley's culvert pipe for the farming sector. Designed as a cost effective light weight alternative to traditional culvert pipes, Agriduct can be used for gateway crossings, piping open drains or anywhere else on the farm requiring an economical pipe system.



Agriduct is available in 100, 150mm diameter in 6m lengths and 175, 225, 300 and 375mm diameters in 5.0m lengths.

Agriduct is solvent socketed one end for 100, 150 and 175mm diameters and for 225, 300 and 375mm diameters has ring joint socketed ends. If a water-tight joint is required a Z ring should be used in the larger sizes.

MINIMUM GROUND COVER REQUIREMENTS

1. No traffic load and light stock movement required ground cover minimum of 500mm
2. Under traffic loads and heavy movement required ground cover of 700mm

Product code numbers are as follows:

Product Code	Diameter DN (mm)	Solvent Socket	RRJ Lock
550.100.6	100	✓	-
550.150.6	150	✓	-
550.175.5	175	✓	-
550.225.5	250	-	✓
550.300.5	300	-	✓
550.375.5	375	-	✓



INSTALLATION INSTRUCTIONS

1. Backfill material - all material used for backfill and bedding should be of a granular non cohesive type i.e. sand, scoria, crushed metal etc, with a maximum particle size of 7mm.
2. The Trench should be excavated to a width of pipe diameter (D) + 300mm to allow for compaction of the backfill material and to a depth of 100mm below the pipe for bedding.
3. Backfill material should be placed in layers not exceeding 150mm and hand compacted, it is critical to ensure the pipe is adequately haunched

N.B. it is important to ensure the backfill is not over compacted.

Granular backfill material should be placed to a minimum of 100mm above the top of the pipe after which ordinary fill material should be used.

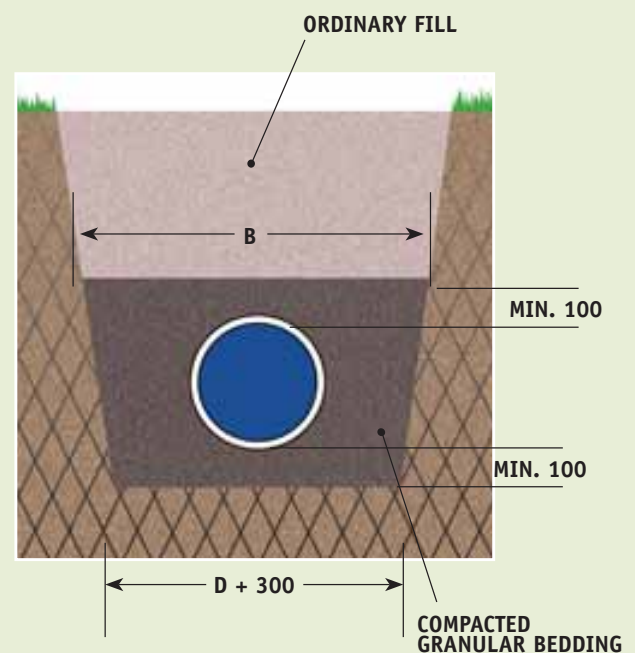

DRAINFLO

Drainflo is manufactured from high density polyethylene, with a corrugated profile wall to give high crush resistance, flexibility and lightness. Drainage lowers the ground water level by removing the “excess” or “surplus” water from the soil, but moisture is still retained in the pores of the soil.



DRAINAGE HAS THE FOLLOWING MAJOR BENEFITS:

1. Improves soil aeration – allows oxygen into the soil to encourage micro organism growth and better utilization of fertiliser and natural fertility.
2. Runoff of natural or rain irrigated effluent and fertilizers, which pollute local streams and rivers, is reduced.
3. Improves soil structure by allowing worms better conditions for activity.
4. Crops are earlier as the sun warms the soil quicker.
5. Plant growth is more vigorous as roots go deeper and are more resistant to drought and winds.
6. Improves fertilizer utilization and absorption into the pasture via deeper root penetration.
7. Discourages rushes, sedges and buttercup etc. (wet growth plants).
8. Reduces surface pugging by vehicles and stock.
9. Reduces animal health problems such as footrot etc. caused by wet conditions.
10. Allows for warm dry paddocks for calving, lambing, marking and feeding out.
11. Means cleaner cows in the milking shed and less chance of contamination.

FITTINGS

Fittings available for Drainflo, Draincoil, Heavy Wall Drain “Road Drain” and Drainflo with Filter Sock are below. If junctions are required for 65mm Drainflo, Marley 65mm Downpipe fittings can be used.

	Joiner	Junction	Reducing Junction 110/160	Reducing Joiner 110/160
65mm	✓	-	-	-
110mm	✓	✓	-	-
160mm	✓	✓	✓	✓

DRAINFLO



Drainflo is manufactured from high-density polyethylene material, with a corrugated profile wall to give high crush resistance, flexibility and lightness.

Drainflo has slots cut at the bottom of the corrugations and spaced around the circumference. Drainflo is also available unslotted (Draincoil).

Drainflo is designed for the economic removal of excess ground water in pasture, cropland, orchards, playing fields, roading and construction work. It can also be used in effluent soakage fields, retaining wall drainage and stormwater diversion.

PRODUCT RANGE

Product Code Drainflo	Pipe O.D. (mm)	Coil Length (m)
400.65.15HP	65	15
400.65.30	65	30
400.65.150	65	150
400.110.15	110	15
400.110.30	110	30
400.110.100	110	100
400.160.15	160	15
400.160.45	160	45

PRODUCT DIMENSIONS

Drainflo Nominal Size	160mm	110mm	65mm
Mean outside diameter	159.5mm	110.2mm	68.4mm
Mean inside diameter	139.0mm	94.0mm	55.5mm
Slot area / metre	9180mm ²	7668mm ²	5560mm ²
Slot dimensions (mm)	15 x 1.7	12 x 1.5	8 x 1.5

COIL DIMENSIONS

Nominal size (mm)	Coil Length (m)	Coil O.D. (m)
160	45	1500
110	100	1500
110	30	1000
65	150	1350
65	30	750
65	15	650

DRAINCOIL



Draincoil is easily identified by twin yellow stripes along its length.

Draincoil can be used where root penetration is a problem, for example when the drain passes under or near trees or hedges, or where a low cost water disposal pipeline is required.

Product Code Draincoil	Pipe O.D. (mm)	Coil Length (m)
500.65.15U	65	15
500.65.30U	65	30
500.65.150U	65	150
500.110.15U	110	15
500.110.30U	110	30
500.110.100U	110	100
500.160.15U	160	15
500.160.45U	160	45



Refer to page 18 for flow chart information.

HEAVY WALL DRAINFLO



Heavy Wall Drainflo is made from high-density polyethylene material, with a corrugated profile but with greater wall thickness. The increased wall thickness provides higher crush resistance at the expense of flexibility.

Heavy Wall Drainflo has slots cut at the bottom of the corrugations and spaced around the circumference. Heavy Wall Drainflo is also available unslotted (Heavy Wall Draincoil).

Heavy Wall Drainflo is easily identified by twin red stripes along its length and is designed for use in high load applications, is cost effective and easy to install.

110mm Heavy Wall Drainflo meets the requirements of Transit New Zealand Specification NRB F3: 2000 and subsequent amendments. Heavy Wall Drainflo is tested to AS 1462.22

PIPE STIFFNESS

Product	SN Rating Load to achieve 5% deflection (kn/m/m)
65mm Drainflo	5
110mm Drainflo	5
160mm Drainflo	4
110mm Heavy Wall Drainflo	10
160mm Heavy Wall Drainflo	8.5
110mm Punched PVC	5
60mm Punched PVC	5

PRODUCT RANGE

Product Code Drainflo	Pipe O.D. (mm)	Coil Length (m)
400.110.30HW	110	30
400.110.100HW	110	100
400.160.45HW	160	45
400.110.4HW	110	4
400.160.4HW	160	4

Dimensions		
Heavy Wall Drainflo	160mm	110mm
Mean outside diameter	159.5mm	110.2mm
Mean inside diameter	138.5mm	93.0mm
Average weight/metre	1.0kg	0.661kg
Slot area/metre	9180mm ²	7668mm ²
Slot dimensions (mm)	15 x 1.7	12 x 1.5
Coil sizes	45m	30 & 100m
Straight lengths	-	4mt

DRAINFlo WITH FILTER SOCK



Drainflo with Filter Sock fitted, has been developed to provide fast and cost effective installation, to make life easier for Drainflo users.

The pre-fitted thermal bonded Polypropylene filter sock provides the combined functions of filtration and separation to prevent excess fines in the water, entering the pipeline and causing silting up of the pipe bore.

BENEFITS OF FILTER SOCK ARE;

- High permeability to air and water
- Resistant to mildew, moisture and rotting
- Lightweight and high bulk, specific gravity 0.91
- Exceptional dimensional stability
- High tear strength, high tensile strength
- Non fray
- High spectrum of resistance to most chemicals
- Low pore size to prevent root fibre penetration

Description	Product Code	Dia Ø	Coil Length	Colour of Filter Sock
110mm dia x 100m coil Drainflo with Sock	400.110.100FS	110	100	White
110mm dia x 100m coil Heavy Wall "Road Drain" Drainflo with Sock	400.110.100HWFS	110	100	Red
160mm dia x 45m coil Heavy Wall "Road Drain" Drainflo with Sock	400.160.45HWFS	160	45	Red

SPECIFICATIONS

CHEMICAL AND BIOLOGICAL RESISTANCE

High density polyethylene is resistant to acids (particularly soil acids), alkalis, non-aromatic solvents and oils.

However, when Drainflo is likely to be subject to discharge of large volumes or a concentrated effluent, confirmation of suitability should be obtained.

High density polyethylene is not subject to attack nor will it support the growth of bacteria. However, iron ochre or similar soil bacterial growths formed when certain ground waters come into contact with air can cause blockage of the inlet holes or in extreme conditions will block the pipe bore. This problem should be discussed with a qualified drainage consultant.

PIPE GRADE

In general pipe gradients between 0.6% and 1.2% are practical and most efficient. Steeper grades obviously produce greater discharges than flatter grades, but should be used with caution.

A water velocity of 0.5m/sec is desired to flush out fine sand or coarse silt which may enter the pipe. Accurate control of trench grade and hence pipe grade is required.

Flatter grades need to be treated with caution due to low flow rates and possible silting.

DRAIN SPACING

The distance between parallel lines of drains for example, in a paddock, depends on the soil permeability and the drain depth.

The following information is offered as a guide only.

The Company cannot accept any responsibility for decisions based on this guide since the actual drain spacing and depth is determined from specific soil permeability tests and survey results.

For drains laid at 0.6 - 0.9m and 0.9 - 1.2m deep; spacing for the listed soil types will be of the order.

DRAIN SPACING VS SOIL TYPE

	Effective drainage distance each side of pipe (m) at a drain depth of:	
	0.6 - 0.9m	0.9 - 1.2m
Sand	15.0 - 23.0	23.0 - 45.8
Sandy Loam	12.0 - 15.3	15.3 - 23.0
Loam	10.5 - 14.0	12.0 - 15.0
Clay Loam	6.0 - 9.0	7.5 - 10.5
Sandy Clay	5.2 - 6.0	6.0 - 7.5
Clay	3.5 - 4.5	4.7 - 5.2

STANDARDS

Drainflo substantially exceeds the requirements of AS 2439 "Perforated Plastics Drainage and Effluent Pipe and Fittings".

PIPE LAYING

The long term performance of pipe laid with a full gravel surround is superior to the alternatives. Topsoil backfill should be used only with the agreement of the professional advisor.

THREE TYPES OF BEDDING MAY BE USED:

Type A: Gravel Surround

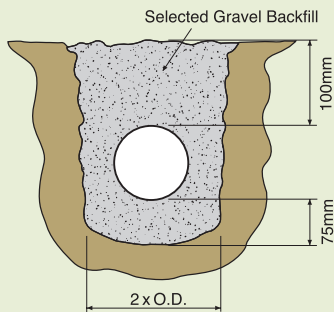

Type B: Partial Surround

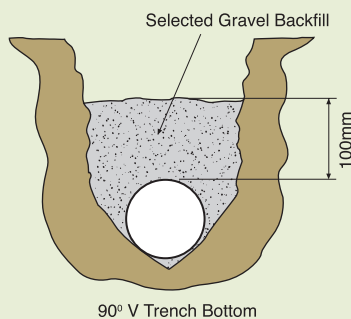

Type C: Soil Backfill

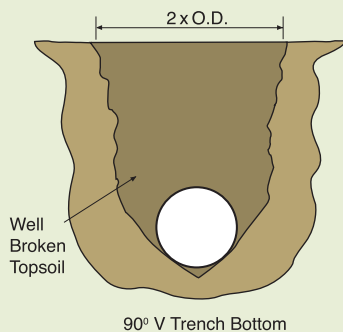

DIGGING THE TRENCH

The trench should be dug not wider than a spades width. Ensure that the trench bottom is smooth and flat and runs on an even flow downgrade. A suitable downgrade is to allow a steady, even flow. A suitable downgrade is about 1 in 50 (20mm drop per metre of drain).

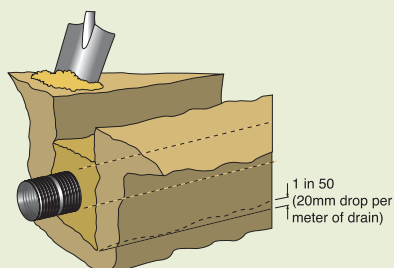

If possible leave this drain open until a period of rain proves that water will run freely to the discharge point.

INSTALLATION

DESIGN

The design of a land drainage system requires the experienced evaluation of a large number of factors e.g land configuration, soil porosity, proposed crop requirements etc.

We recommend that, wherever possible, professional advice be sought from appropriate qualified persons.

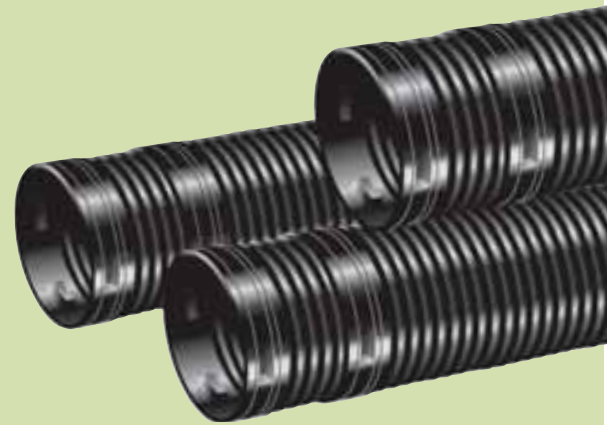

TRENCH DEPTH

This will be determined by the professionally qualified designers. In average pastoral and horticultural installations a minimum depth of 0.6m is recommended. This will provide reasonable protection against farm traffic loads. If the ground is soft or peaty or heavy wheel loads are frequent, we suggest using Heavy Wall Drainflo.

Under driveways or roads where frequent traffic is usual we recommend Heavy Wall Drainflo laid to a minimum depth of 0.75m and fully surrounded with gravel.

There is no practical maximum depth of any size of Drainflo provided the width of the trench at the pipe is not greater than 2 x the O.D. and Type A bedding is used.

GRAVEL FILL

Gravel selected for the pipe surround should have as low a fraction of particles below 1.5mm as possible (the slot width is 1.5mm); preferably below 5%.

Stones larger than 20mm are also unwanted. The commercially available 7mm – 20mm gravel is suitable although in very wet areas a minimum nominal of 5mm will be better.

Excess fines (below 1.0mm) will eventually enter the pipe and possibly cause settling of the backfill. In this situation, use Drainflo with Filter sock as an option.

The gravel base should be placed and screeded to grade, the pipe laid centrally and the backfill placed so that the space between the pipe and the trench wall is completely filled. Where the pipe is laid directly on the soil it should be placed in the 90°V and then backfilled.

SOIL BACKFILL

The excavated soil, well broken up, should be placed over the gravel and compacted.

EFFLUENT PIPE & CAMLOCK FITTINGS

Dairy shed effluent can be used as an alternative to fertilize pasture or to complement existing pasture fertilization processes.



By using dairy shed effluent for pasture irrigation/fertilization, utilization of the nutrients present in the effluent can make significant savings in fertilizer costs. These savings will vary depending on individual herd sizes.

Effluent pipes are specifically designed and installed as an above ground pipeline system to effectively and economically get dairy shed effluent out into the pasture.

PERFORMANCE

Effluent pipes are manufactured from medium density polyethylene (MDPE) and are tested in accordance to AS/NZS 4130.

U.V. RESISTANCE

Effluent pipes can be installed for above and below ground applications due to the excellent pipe U.V. stability resistance.

PRESSURE RATING

Effluent pipes are pressure rated at a maximum operating pressure of 8 bar, PN 8 at 20° Celsius.

O.D. (mm)	m/head	(bar)	psi
75	80	8	116
90	80	8	116

ELEVATED TEMPERATURES

When the pipeline operates in elevated temperatures, the pressure rating must be de-rated.

Also, where the temperature fluctuates, the pipe system must be designed to allow for stress experienced by alternating expansion and contraction.

PRODUCT RANGE AND CODES

Effluent pipes are available in 75 and 90mm outside diameter and coil lengths of 50 and 100m.

Code	O.D. (mm)	I.D. (mm)	Coil (O.D.)
220.75.50	75	65.50	50
220.75.100	75	65.50	100
220.90.50	90	78.90	50
220.90.100	90	78.90	100

Effluent – Irrigator drag hose is available in 57 and 63mm outside diameter sizes (O.D.).

IRRIGATOR DRAG HOSE

Code	Pressure	O.D. (mm)	Coils (m)
220.57.50.DRG	6 bar (87psi)	57	50
220.63.50.DRG	6 bar (87psi)	63	50

FITTINGS COMPATIBILITY

Effluent pipes are compatible with a comprehensive range of camlock fittings, Marley Oasis Metric range of fittings and Drag hose fittings to ensure a reliable and easy problem free installation.

CAMLOCK FITTINGS - PRODUCT RANGE

DOUBLE HOSE-TAIL



HOSE-TAIL TO MALE



MALE ADAPTOR TO REDUCING HOSE-TAIL



MALE ADAPTOR STOP PLUG



MALE ADAPTOR TO FEMALE BSP



FEMALE COUPLER TO HOSE-TAIL



MALE ADAPTOR TO HOSE-TAIL



MALE ADAPTOR TO MALE BSP



MAGNUM SPOUTING

Magnum commercial spouting is a rugged half round PVC solvent cement system, designed for the collection and conveying of rainwater, which complies with E1 surface water and B2 durability requirements of the New Zealand Building Code.

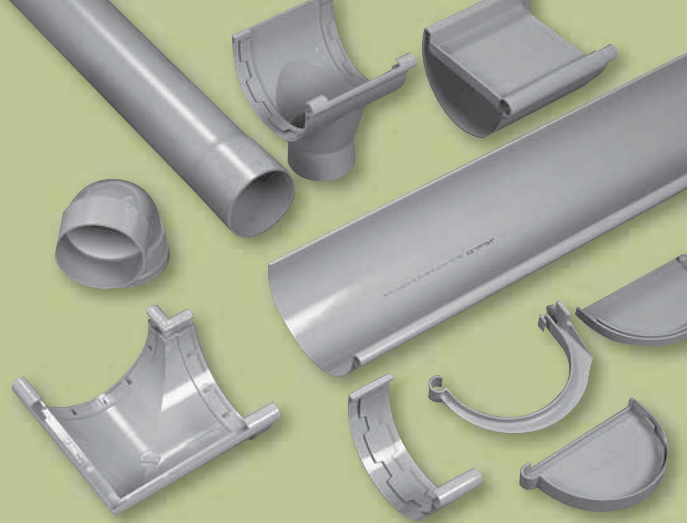

Magnum is ideally suited to collect rainwater from large roof areas in commercial, agricultural and domestic applications that include:

- All farm utility buildings, warehouses, sports stadiums educational facilities, multi storeyed dwellings, large domestic dwellings, correctional facilities, retirement villages and motels.

FEATURES AND BENEFITS

Rugged solvent cement PVC system, half round profile, fast & simple to install, won't rust or rot, cost effective & long lasting, great for coastal locations, low maintenance - external brackets lend to ease of clearing debris and large roof area drainage.

COLOUR - Light Grey AS2700 N33

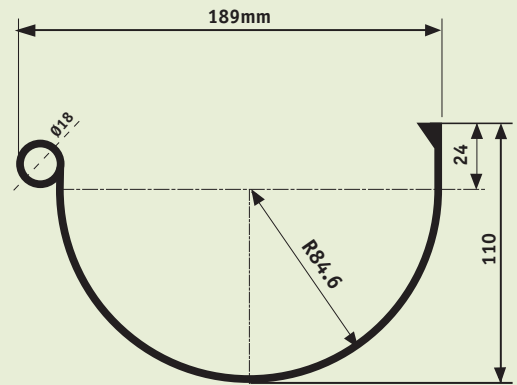

Spouting size 14,300m²

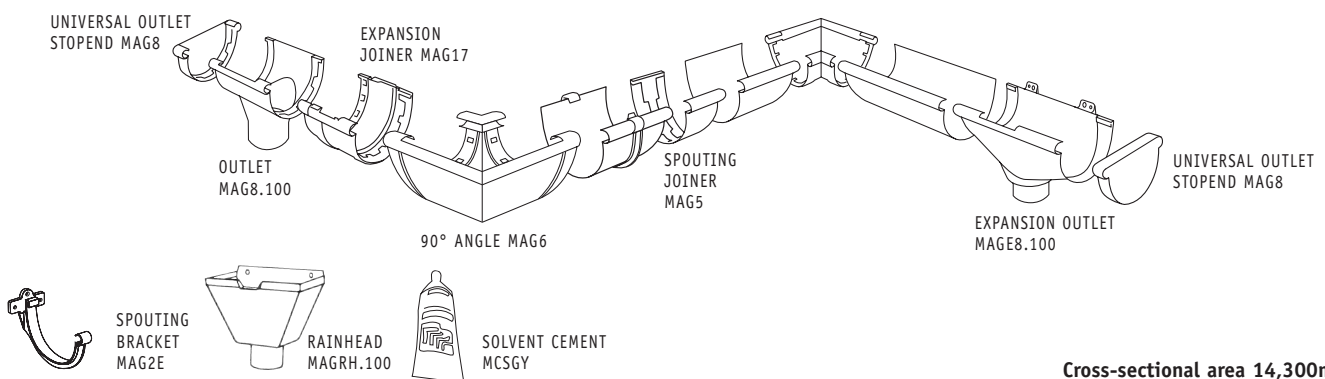

Cross-sectional area 14,300mm²

COMPONENT	CODE	PRODUCT	PACK QUANTITY	COMPONENT	CODE	PRODUCT	PACK QUANTITY
MAGNUM SPOUTING GREY	MAG1.4		1 X 4M LENGTH	MAGNUM OUTLET 100mm GREY	MAG8.100		EACH
MAGNUM SPOUTING BRACKET GREY	MAG2E		EACH	MAGNUM UNIVERSAL OUTLET STOPEND GREY	MAG8		EACH
MAGNUM UNIVERSAL SPOUTING STOPEND GREY	MAG9		EACH	ROUND DOWNPIPE 100mm 4m Length GREY	RP100.GY.4		1 X 4M LENGTH
MAGNUM SPOUTING JOINER GREY	MAG5		EACH	88° SOCKET BEND 100mm GREY	RB2.100.GY		EACH
MAGNUM EXPANSION JOINER GREY	MAG17		EACH	PIPE CLIP SADDLE - ALUMINIUM	140.100HB		EACH
MAGNUM 90° ANGLE GREY	MAG6		EACH	MAGNUM RAINHEAD GREY	MAGRH.100		EACH 200mm
MAGNUM EXPANSION OUTLET 100mm GREY	MAGE8.100		EACH	WELDING SOLVENT GREY	MCS.GY		EACH

RAINHARVESTING

The Marley Rain Harvesting System comprises a number of unique and cost effective components that are designed to work with the Marley PVC range of spouting and downpipes to help make tank water as clean as possible.



HOW SAFE IS THE WATER YOU ARE COLLECTING?

When collecting rainwater as a partial or total source for a water supply, it is essential the design of the system meets the need for potable (safe drinking) water.

Water collected from a roof and stored and distributed from a water tank, can contain a nasty range of pollutants that can contaminate your water, for example bacteria from bird droppings, insects, rotting debris and airborne dusts (containing heavy metals). It is advisable to have your tank water analysed to check its potability.

7 STEPS TO RAIN HARVESTING POTABLE WATER

- 1 Ensure the roof surface is suitable for collecting potable water.
- 2 Ensure spouting is installed according to the Building Code, allowing for adequate fall and installing suitable expansion outlets or spouting outlets to make certain water does not pond in the spouting.
- 3 Install debris diverter rainheads with screens to direct leaf litter and larger debris items out of the flow of the water.
- 4 Fit an appropriate sized first flush diverter, to divert the first most contaminated rain water from entering the tank.
- 5 Attach tank overflows and vent flaps to tanks to ensure the tank is vented properly allowing air to circulate.
- 6 Attach insect screens to rainheads and tanks to prevent insects and vermin entering the tank.
- 7 To assist in cleaning the tank, install a tank vacuum kit to suck water from the bottom of the tank (anaerobic zone - 'dirty zone') when the tank is full to overflowing.



OASIS 6 BAR & 9 BAR HYDRAULIC CHART

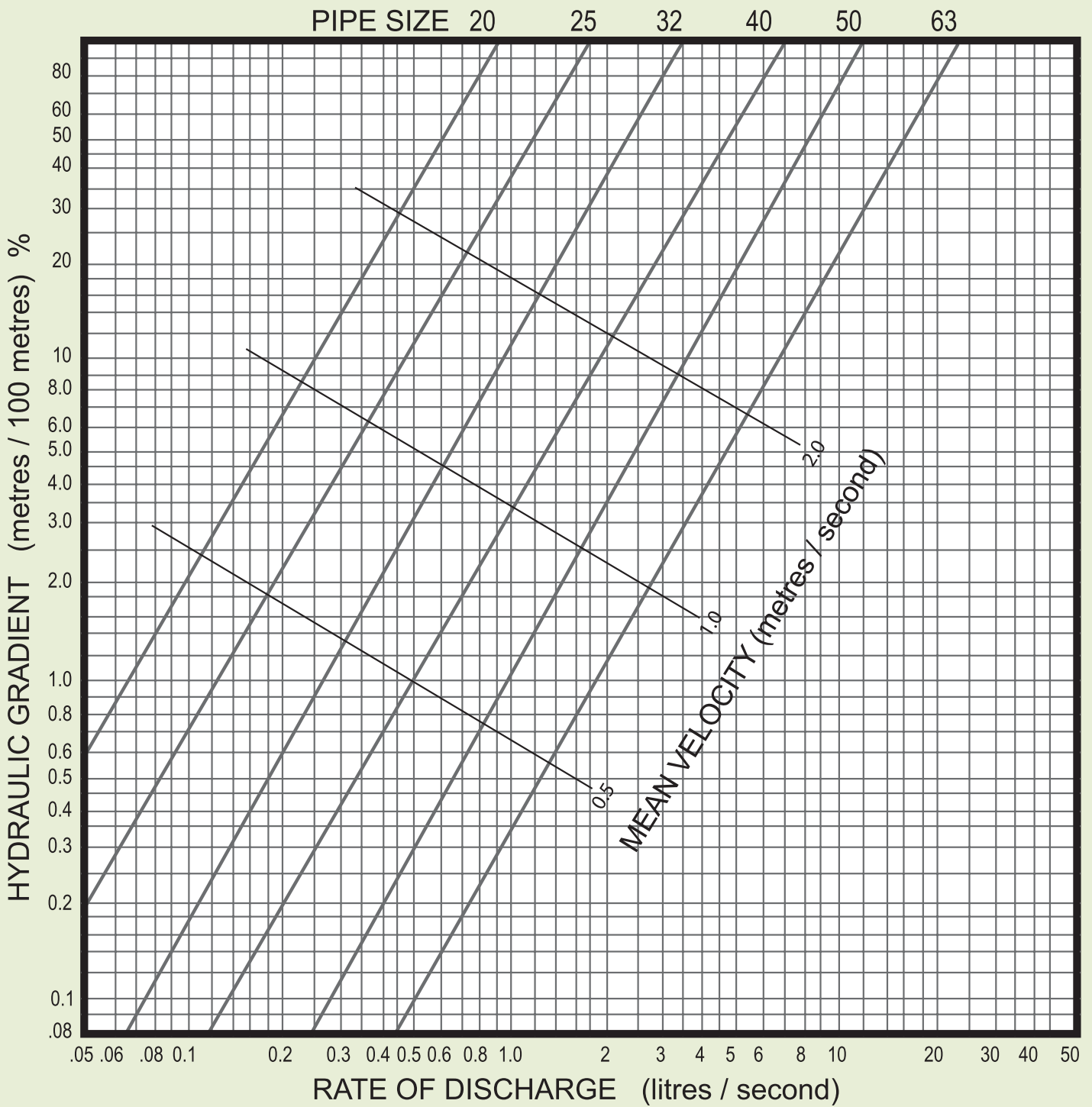

ENDUROFLEX2 HYDRAULIC CHART

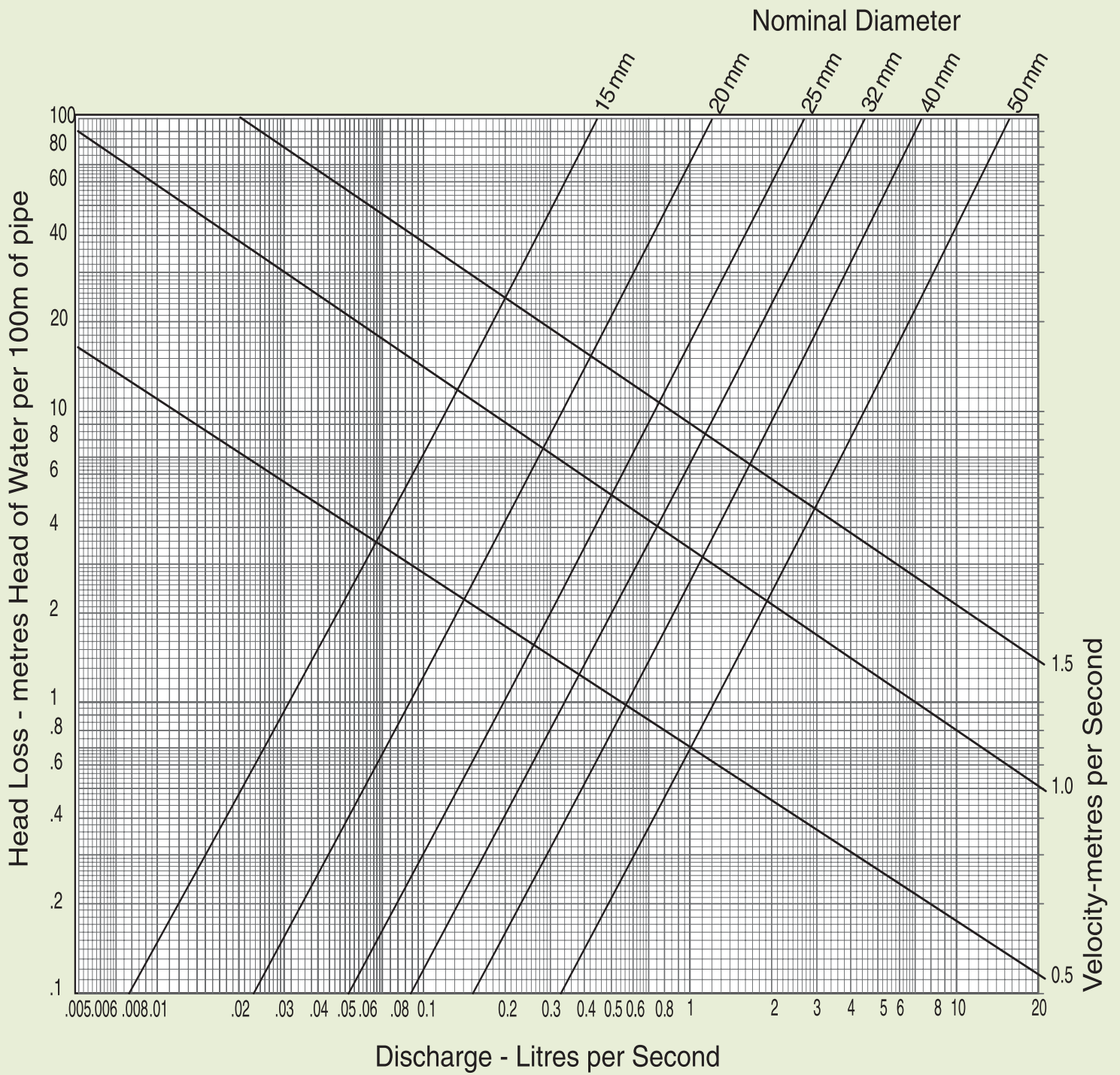

DRAINFLO HYDRAULIC CHART

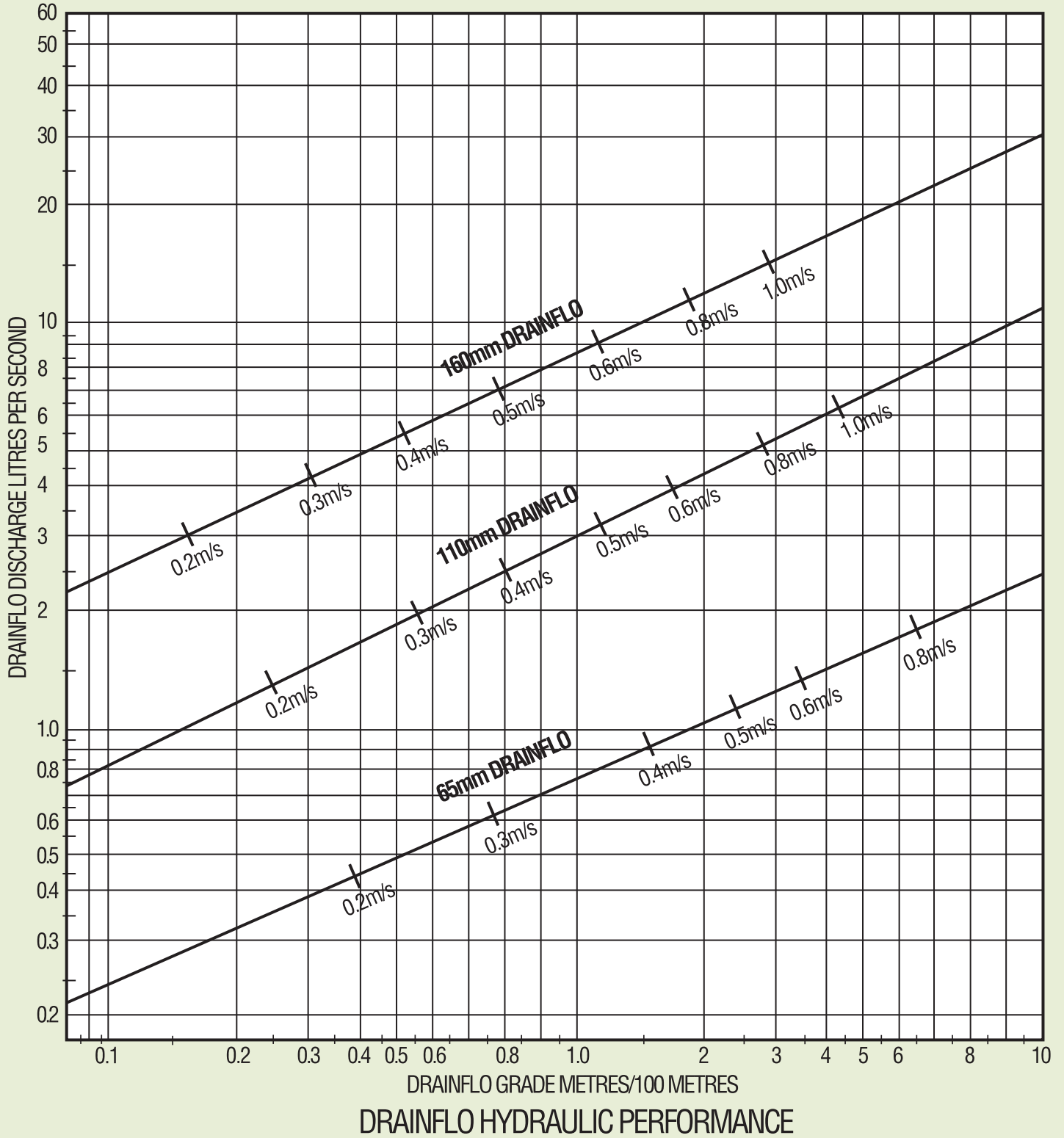

NOTES

NOTES



FUTURE-PROOF BUILDING

WORKING WITH MARLEY
FOR A BETTER TOMORROW

DISCLAIMER

This technical catalogue has been compiled by Marley New Zealand Limited ("The Company") to promote better understanding of the technical aspects of the Company's products to assist users in obtaining from them the best possible performance.

The technical catalogue is supplied subject to acknowledgment of the following conditions:

The technical catalogue is protected by Copyright and may not be copied or reproduced in any form or by any means in whole or in part without prior consent in writing by the Company.

Product specifications, usage data and advisory information may change from time to time with advances in research and field experience.

The Company reserves the right to make such changes at any time without notice.

Correct usage of the Company's products involve engineering judgements which cannot be properly made without full knowledge of all the conditions pertaining to each specific installation. The Company expressly disclaims all and any liability to any person whether supplied with this publication or not in respect of anything and of the consequences of anything done or omitted to be done by any such person in reliance whether whole or partial upon the whole or any part of the contents of this publication.

No offer to trade, nor any conditions of trading, are expressed or implied by the issue or content of this manual.

Nothing herein shall override the Company's Conditions of Sale, which may be obtained from the Registered Office or any Sales Office of the Company.

This technical catalogue is and shall remain the property of the Company, and shall be surrendered on demand to the Company.

AUCKLAND - Mahia Road, Manurewa,
Private Bag 802, Manurewa.

Sales Department Tel: 09 279 2777

Direct Fax: 09 279 2778

Freefax: 0800 652 621

Head Office Tel: 09 279 2799

Fax: 09 279 2798

CONTACT CENTRE: 0800 222 922

CHRISTCHURCH

Shands Road, Hornby,
PO Box 16233 Christchurch.

CONTACT CENTRE: 0800 222 922

For further information: **0800 MARLEY** (0800 627 539) www.marley.co.nz

an *Aliaxis* company

www.marley.co.nz

 **MARLEY**